

# las olas

CONCEPTUAL DESIGN VISION » EASTERN CORRIDOR

CITY OF FORT LAUDERDALE » JUNE 2021





CITY OF FORT LAUDERDALE

lasolas

Prepared for the City of Fort Lauderdale by:  
**THE CORRADINO GROUP**

# » CONTENTS



» Introduction.....	1
» Traffic Analysis.....	5
» Public Engagement .....	13
» Existing Conditions.....	21
» Overall Vision and Area Recommendations.....	39
» Colee Hammock.....	47
» The Isles.....	60
» The Beach.....	77
» Implementation Sequence and Cost Estimates.....	83







# » INTRODUCTION



## » INTRODUCTION



When first constructed in 1917, a few years after Fort Lauderdale was incorporated in 1911, Las Olas Boulevard was just a dirt road. At the time, the area around Las Olas was swampy wetlands on the way to Fort Lauderdale Beach. As time changed, the street took on other jobs. As the area of what is now the Las Olas Isles was dredged in the 1920s, it became a connection not only to the beach, but to local residences with waterfront views still valued today. At the

same time, in 1921, Colee Hammock's lots were subdivided, with all but 14 lots being sold for development. Las Olas Boulevard became a connection between residences, the beach, and the rest of the City. Post World War II, the commercial segments of the corridor were constructed, with significant investment in the 1970s in the development of the Downtown, and a major renovation program in the 1980s that greatly increased property values. These historical influences helped shape the distinct character areas that we see today.

Today, Las Olas Boulevard is not only Fort Lauderdale and Broward County's most famous street, it is one of the most iconic streets in all of Florida. For decades it has served as

a major employment center at the heart of Downtown, a major attraction with historic retail, a plethora of restaurants, year-round events and festivals, as well as being a prized residential destination. Las Olas Boulevard attracts visitors from across the region and around the world.

Over time, the Corridor has evolved with the City, retail and commercial spaces have continued to adapt, vehicle traffic has impacted community character and quality of life, landscaping and street furniture are in need of refreshing, and climate change impacts make it necessary to rethink the civil engineering of underground infrastructure.

For decades, the redesign of Las Olas Boulevard has been on the minds of many. Attempts have been made on segments of the corridor, but there has not been a holistic vision in recent history. The diversity of place and the varied roles the street plays have resulted in a number of ideas, many competing with each other on how Las Olas should evolve. This has resulted in a variety of opinions and alternative concepts. One thing everyone can agree on is that Las Olas Boulevard has a high degree of value in the hearts of the City's residents and businesses. Improvements along the entire corridor in a unified concept would better enhance Las Olas's ability to address local transportation and urban design needs, as well as create a high value, marketable image for the future.

Through discussions that began in May 2017 in regards to an upcoming potential project on Las Olas Boulevard, it was determined that the project should not move forward. Instead, a unified effort was needed that would evaluate the transportation, landscaping, planning and urban design needs of the corridor as a whole to create a process that would build consensus on the future of a world-class corridor.

This effort was led by the two district commissioners, Vice Mayor Steve Glassman and Commissioner Ben Sorensen, with assistance from the designated Las Olas Working Group. The Working Group consisted of representatives from various stakeholders along the entire corridor who helped guide the vision. The efforts of the Working Group included hearing presentations from the various stakeholders on their concerns and providing comments on the issues and reviews of the vision over a 2.5 year timeframe from September 2018 to February 2021.

## The Corridor

Las Olas Boulevard today has five distinct character areas; Downtown, The Shops, Colee Hammock, The Isles, and the Beach. There are a number of variables that comprise the makeup of each segment of the street:

1. The street consists of pedestrian areas, bicycle lanes, asphalt for cars and vehicles - all things that move and are in motion.
2. There are amenities throughout such as landscaping, street furniture, signage and lighting. These elements are static and have different purposes in different parts of the street. They are the basis of the visual identity for each segment of the street.
3. The street has different roles during the day and at nighttime. The street also differs in Weekday, Weeknight, Weekend and Event operations.
4. There is a need to evaluate underground infrastructure improvements, particularly related to flooding. This is particularly true in the Isles. It is highly recommended that the streetscape recommendations in this analysis be implemented after flood mitigation improvements have been developed.

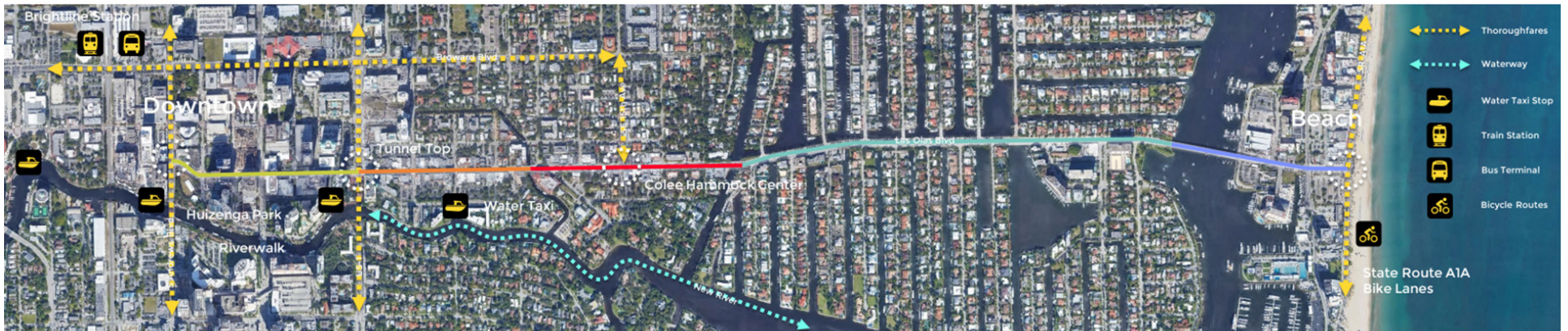

### 2.4 miles long

It would be one of the longest, continuously protected, multimodal corridors in South Florida

### Connecting Regional Trails

Safe connections will shorten the perceived distance between Downtown Fort Lauderdale and Las Olas Beach

### Coordinating with Transit

Water taxis, Brightline, and bus transit should be coordinated.







# » TRAFFIC ANALYSIS



## »TRAFFIC ANALYSIS

Understanding traffic patterns and performance of Las Olas Boulevard is essential in achieving the primary goal of mobility. A balance must be struck between the needs of drivers, pedestrians and bicyclists, while also protecting and preserving the character and quality of life of each of the distinct areas, each of which behave differently in form and function, specifically from the perspectives of land use, urban design, landscape, and particularly mobility. From the perspective of mobility, Las Olas Boulevard is asked to be both a Main Street and a regionally significant corridor, in each case serving the needs of both automobile traffic and walkers and bikers. For the residents and businesses that must use it every day as a destination, it's a critical part of the daily commute. For people attracted here from other places, its a regional connector, serving as the primary route through the community connecting I-95 and the Beach. In all respects it works in tandem with Broward Boulevard.

As with any project that seeks to balance multimodal needs, it is first important to understand the primary issues related to traffic. The defining aspect of any transportation system is space in the right-of-way, as each component of the transportation network, like swales, sidewalks, bicycle facilities, vehicle lanes and medians occupy space that could be utilized for other modes depending on what is needed or to be encouraged. Some character areas need to emphasize traffic flow, while others must protect neighborhood character, or further the ability to walk or bike to contribute to local quality of life and the foot traffic that is supportive of retail. Optimizing the performance of Las Olas Boulevard therefore requires an understanding of how much space is needed for cars.

To better understand this a traffic analysis was conducted, first by collecting data, and then analyzing intersections and roadway segments for level of service (LOS), speed and safety.

**EXISTING PEAK HOUR ROAD SEGMENT LEVEL OF SERVICE ANALYSIS**

Roadway Segment	Roadway Type	Existing 2 Way Peak Hour Volumes	Peak Hour LOS D Volume	Level of Service
Seven Isles Drive to Seabreeze Boulevard	4 Lanes Undivided	1665	2482	C
Isles of Capri to Seven Isles Drive	4 Lanes Divided	2007	2628	C
SE 15th Avenue to Isles of Capri	4 Lanes Undivided	2308	2482	C
SE 11th Avenue to SE 15th Avenue	2 Lanes Undivided	1044	1197	C
SE 6th Avenue to SE 11th Avenue	2 Lanes Divided	1177	1264	C
Andrews Avenue to SE 6th Avenue	4 Lanes Undivided	1189	2482	C

Data was collected during the peak months of March and April of 2019, in the form of 30 turning movement counts and 30 speed and volume counts. Additionally, crash data for the previous 5 years was collected.

This data was analyzed using a methodology and computer software acceptable to the City of Fort Lauderdale and the Florida Department of Transportation (FDOT).

To perform the analysis, the existing counts were examined to find out how the network performed today, in the existing condition. To this were added the volume of future development already planned and approved by the City, plus anticipated population growth, to find the future year performance in 2035. The results in both cases were measured against the level of service standard set by the City's Comprehensive Plan, to determine what would need to be done to improve the intersections and roads by adjusting signal timing, adding or subtracting lanes, opening or restricting flow, or making safety improvements as appropriate for each character area.

For reference, the City's LOS Standard is "E". This is measured on a continuum from "A" to "F", with each letter equating to a percentage of utilized capacity. For example LOS E, equates to between 90% and 100% utilization of capacity. All of this is measured at the busiest hours of the day.

## Roadway Analysis

The future conditions analysis for the roadway links show that to maintain acceptable LOS performance in 2035, Las Olas Boulevard requires two lanes of travel, or one lane in each direction west of SE 15th Avenue, and four lanes of travel, or two lanes in each direction, east of SE 15th Avenue.

It was found that westbound traffic from the Beach and the Isles is generally heading towards the Shops, Downtown, US-1, or I-95. For the Beach and Isles areas, this is a one-way in, one-way out situation. However, once drivers reach SE 15th Avenue, they have the option to head north on SE 15th Avenue to Broward Boulevard to connect to US-1 and I-95, or head northeast towards Victoria Park. In the heart of

FUTURE PEAK HOUR ROAD SEGMENT LEVEL OF SERVICE ANALYSIS				
Roadway Segment	Roadway Type	FUTURE 2 Way Peak Hour Volumes	Peak Hour LOS D Volume	Level of Service
Seven Isles Drive to Seabreeze Boulevard	4 Lanes Undivided	2135	2482	C
Isles of Capri to Seven Isles Drive	4 Lanes Divided	2573	2628	C
SE 15th Avenue to Isles of Capri	4 Lanes Undivided	2959	2482	E
SE 11th Avenue to SE 15th Avenue	2 Lanes Undivided	1338	1197	E
SE 6th Avenue to SE 11th Avenue	2 Lanes Divided	1509	1264	E
Andrews Avenue to SE 6th Avenue	4 Lanes Undivided	1524	2482	C

Colee Hammock, SE 15th Avenue is the primary connection between Las Olas and Broward Boulevards.

## Intersection Analysis

Traffic congestion and underperformance of a road in terms of level of service, travel time and delay is generally a product of bottlenecks at poorly performing intersections, and not the capacity of the roadway links between them. This is certainly true when looking at Las Olas Boulevard west of SE 15th Avenue, where the performance of the road will meet the LOS standard of “E” with one lane in each direction. Taking a closer look at the intersections along Las Olas Boulevard provided a clearer picture of how to best optimize travel in the corridor, as intersection issues were creating much of the undue delay and congestion, not overall volumes of vehicular traffic.

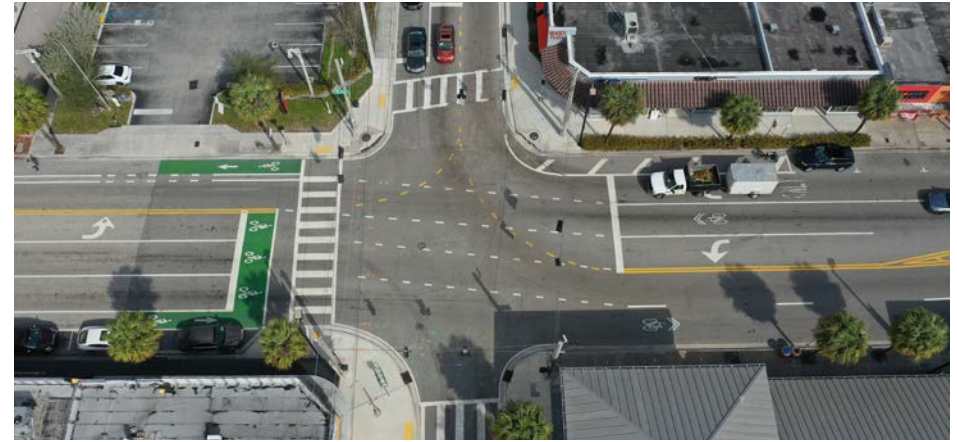

Key traffic concerns noted during the course of public workshops and in the traffic analysis included the intersections of SE 3rd Avenue and Las Olas Boulevard, and SE 15th Avenue and Las Olas Boulevard. During the analysis, it was noted that both intersections had a level of service exceeding the City’s stated standard.

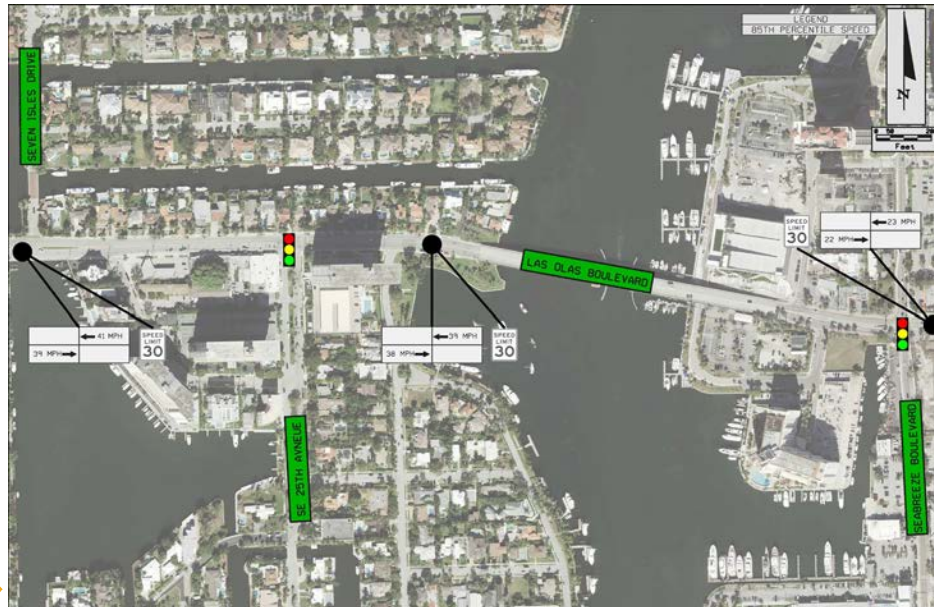

For the intersection of SE 3rd Avenue and Las Olas Boulevard, the City is currently coordinating a study of a one-way pair with Andrews Avenue to determine if this will be a viable solution to improve traffic flow at SE 3rd Avenue and Las Olas Boulevard. This is a very urban location, of which the community character and quality of life fit well with the proposed improvement

For the intersection of SE 15th Avenue and Las Olas Boulevard, different alternatives were evaluated to determine a solution for congestion. These options included multiple roundabout configurations as well as dual left turns on southbound SE 15th Avenue. Each was compared to a “do-nothing” scenario. It was found that while both options would work in the short term, the dual left turn option provided the best long term. It should be

### SE 15TH AVENUE AT LAS OLAS BOULEVARD INTERSECTION ALTERNATIVES ANALYSIS

Alt. #	Intersection Traffic Control	Intersection	Existing AM Peak Hour Delay	V/C	Existing Midday Peak Hour Delay	V/C	Existing PM Peak Hour Delay	V/C	Future AM Peak Hour Delay	V/C	Future Midday Peak Hour Delay	V/C	Future PM Peak Hour Delay	V/C
1	Single Lane Roundabout	SE 15th Avenue and Las Olas	LOS C 17.4 seconds	0.723 (WB)	LOS D 34.2 seconds	0.969 (WB)	LOS E 36.0 seconds	0.977 (WB)	LOS F 51.4 seconds	1.049 (EB)	LOS F 137.7 seconds	1.288 (WB)	LOS F 142.9 seconds	1.314 (WB)
2	Single Lane Roundabout with Free Flow Rights	SE 15th Avenue and Las Olas	LOS B 13.7 seconds	0.687 (SB)	LOS C 19.2 seconds	0.833 (SB)	LOS C 21.0 seconds	0.881 (EB)	LOS E 37.2 seconds	1.02 (EBL)	LOS F 71.7 seconds	1.205 (SB)	LOS F 78.4 seconds	1.306 (EB)
3	Single Lane Roundabout with Free Flow Right WB Only	SE 15th Avenue and Las Olas	LOS B 14.1 seconds	0.702 (EB)	LOS C 19.9 seconds	0.833 (SB)	LOS C 21.3 seconds	0.888 (EB)	LOS E 39.7 seconds	1.05 (EB)	LOS F 76.0 seconds	1.22 (SB)	LOS F 80.1 seconds	1.318 (EB)
4	Addition of a Dual SB LT on SE 15th Avenue (i.e. SB LT, SB LT, SB TRT)- Split Phasing	SE 15th Avenue and Las Olas	LOS C 21.1 seconds	0.52	LOS C 21.4 seconds	0.67	LOS C 24.5 seconds	0.73	LOS C 23.6 seconds	0.64	LOS C 25.1 seconds	0.79	LOS C 28.0 seconds	0.85
0	Existing Geometry and Signal Timings at Intersection (Do Nothing)	SE 15th Avenue and Las Olas	LOS B 19.3 seconds	0.88	LOS C 21.8 seconds	0.93	LOS C 20.4 seconds	0.91	LOS C 33.5 seconds	1.1	LOS D 46.2 seconds	1.24	LOS D 41.0 seconds	1.2

noted that the intersections of SE 15th Avenue/Las Olas Boulevard and SE 15th Avenue/Broward Boulevard are linked, and both should be improved at the same time to optimize the roadway network. Additionally, Colee Hammock, the neighborhood which surrounds SE 15th Avenue, is extremely sensitive to the traffic volumes and speeds that cut through it. As such, the goal here is to balance the flow of traffic with the preservation of the neighborhood character and quality of life. It is believed that by focusing traffic on SE 15th Avenue, a balance can be achieved. Additional study at the intersection of Las Olas Boulevard and SE 16th Avenue is needed to determine the traffic operations at this intersection.

## Crash Analysis

A crash analysis was conducted to see if any safety related improvements may be needed along the corridor. Using available crash data, it was found that the highest number of crashes at Las Olas Boulevard intersections occurred at SE 3rd Avenue, Seabreeze Boulevard, SE 15th Avenue and US-1/Federal Highway. Additionally, it was found that the number of crashes has increased yearly from 2015 to 2019. Various safety related improvements, such as reducing vehicle speeds, increasing visibility at crosswalks, and others, have been introduced into the concept plan across all character areas, particularly the Isles. The chart and map on the following page provides the crash type and general area of crashes.

Crash Data for 2015-2019

	No Injury	Non-Traffic Fatality	Possible Injury	Non-Incapacitating Injury	Incapacitating Injury	Fatal (within 30 days)
Angle	167		25	21	5	1
Bicycle	9		7	9		
Head On	25		6	5		
Left Turn	143		32	15	1	1
Off Road	48		11	5	3	1
Other	627		43	32	4	2
Pedestrian	3		15	20	8	3
Rear End	671		125	31	1	
Right Turn	41			4		
Rollover	24		3	3		
Sideswipe	350		6	8		
Unknown	291		13	15		



Speed Analysis

Due to concerns of speeding along Las Olas Boulevard, an analysis was also undertaken to evaluate speeding along the corridor. Generally, in order to determine that an area has a speeding problem, the speed at the 85% percentile of vehicles traveling on the roadway must exceed the posted speed limit by more than 4 MPH. Speeding was found to be an issue only in the Isles. Effecting safer travel and pedestrian crossings in the Isles is therefore needed, as well as traffic calming measures such as narrowing lanes and improving visibility and visual cues.

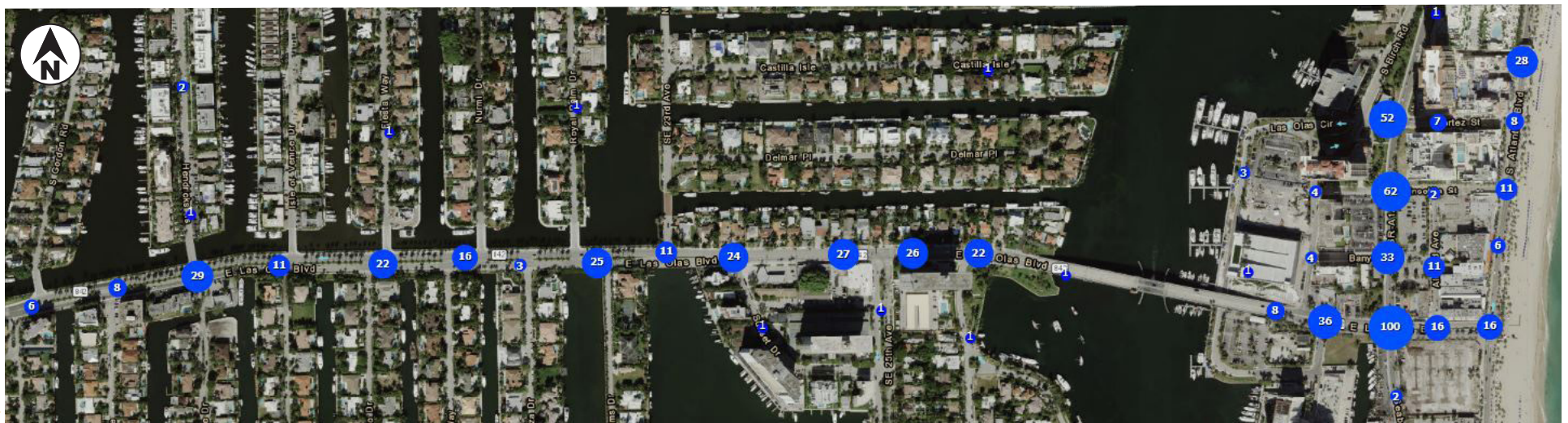









# » PUBLIC ENGAGEMENT



## »PUBLIC ENGAGEMENT

Critical to the success of any complex urban project such as this is public engagement. With hundreds of stakeholders in the five different and diverse character areas there are a plethora of opinions on how the corridor should look, feel and function. The approach here was to listen to everyone, understand the various ideas, develop concepts that balanced transportation professional engineering best practices and public ideas to the best extent possible. The intent was to accomplish as many of the objectives as possible to create a draft set of recommendations for review by stakeholders, then listen again to refine those concepts until consensus was had on a professionally recommended set of alternatives.

The goal of public engagement during the development of the Las Olas Streetscape Conceptual Design was to maintain an open line of communication that would promote coordination with the community, ensure responsiveness to community needs, and facilitate an exchange of information to create a better understanding of local needs and wants. A key outcome of outreach to a highly varied group of stakeholders, inclusive of residents, property owners, and local businesses, was building consensus to develop a unified plan.

The Las Olas Mobility Working Group consisted of residents, businesses, and other entities who represented neighborhood associations, business associations and property owners along the corridor. At the onset, the public engagement plan was designed to have presentations at 3 Las Olas Mobility Working Group meetings, approximately 2 group meetings or 8 one-on-one meetings with stakeholders, 1 Las Olas Mobility Working Group survey,

1 walking tour, 2 public workshops, and 1 conference presentation to the Commission.

The designated approach to public engagement for this project was adjusted during execution to respond to the changing dynamics regarding social interaction as a result of the COVID-19 pandemic. The updated approach included a combination of strategies to transition from in-person engagement methods to more virtual and digital methods.

Through the course of this project, at least 14 working group/workshop meetings and 2 walking tours occurred in February 2020 (in person) and in May 2020 (virtually), over 18 group meetings, and more than 75 one-on-one phone calls with individual residents or small groups (2-4 people) were conducted along with presentations to the City Commission. The general public was also kept informed of the project through tweets and email blasts, and all meetings were open to the general public.



## Local Leadership

The development of the Las Olas Streetscape Conceptual Design, to include public engagement throughout the process, was completed under the leadership of Vice Mayor Steve Glassman and Commissioner Ben Sorensen. From the onset the Vice Mayor and Commissioner provided insight from their constituents and advice on building the stakeholder and outreach lists. Along with City Staff, they also provided input on the public engagement approach.

## Community Representation

Las Olas Boulevard is Fort Lauderdale's marquee thoroughfare. Given its importance to the City as well as the many types of users who live, work, play and use the street, it was important to include residents, businesses, civic and religious organizations as well as the general public in this process. A range of engagement tools (Engagement Methods), as described below, were implemented to achieve representative participation. Given the need to build consensus, and understanding that effective networks were already established, leaders of many homeowner associations and local organizations



were included in periodic meetings, updates and working sessions, and were asked to act as conduits on behalf of their larger membership and constituents through the Las Olas Mobility Working Group.

## Engagement Methods

Public engagement for the visioning process began in October 2019 with a kickoff presentation in meetings with the Las Olas Mobility Working Group and other key stakeholder groups within the City, and continued for the duration of the conceptual design process through March 2021. However, it should be noted that efforts prior to this study had been ongoing with the City since May 2017, where the concept of developing the Las Olas Mobility Working Group originated, with other local efforts predating the Working Group.

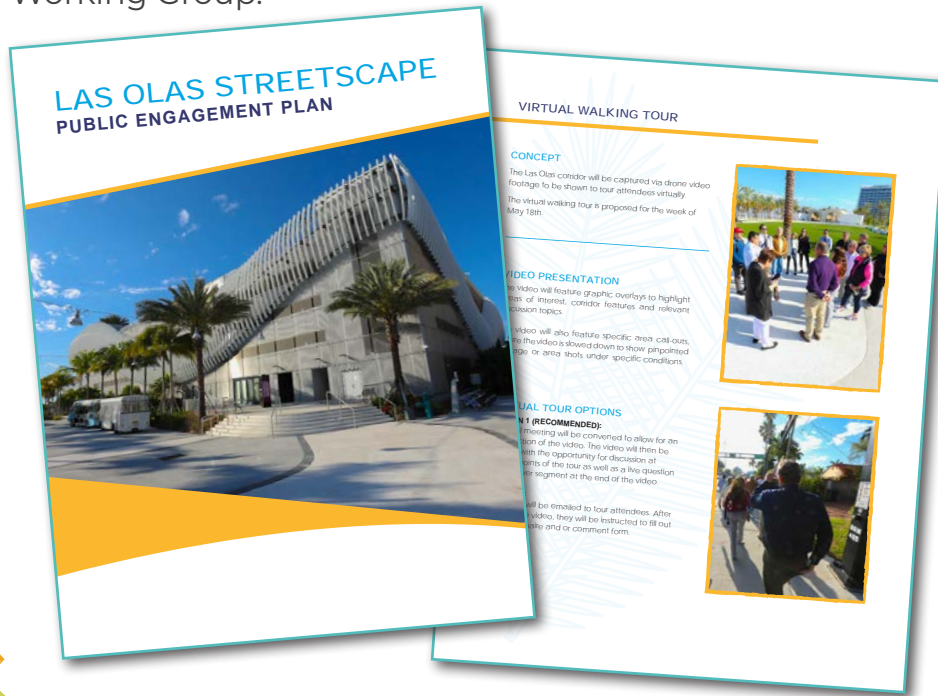

Unfortunately, planned in-person outreach activities had to be transitioned to virtual activities from mid-March 2020 onward, in response to social distancing guidance surrounding the pandemic.

The Las Olas Streetscape public engagement toolkit included:

- » Stakeholder Meetings:
  - o Dedicated working and progress meetings with the Las Olas Mobility Working Group
  - o Virtual meetings with HOAs, Civic Groups, Business Organizations, Churches, Residents, and individual stakeholders as requested
- » Corridor Walking Tour
- » Virtual Walking Tour
- » Digital Fact Sheets
- » Virtual Presentations (in lieu of in-person workshops)
- » Video Presentations
- » Social Media Channels
- » Virtual Newsletters (E-blasts)
- » Surveys
- » Las Olas Mobility Working Group webpage
- » Dedicated email address for public comments

## Stakeholder Meetings

In an effort to promote as inclusive a process as possible, the consultant team undertook a robust schedule of one-on-one and group stakeholder meetings throughout the conceptual design process. With a focus on building

consensus and considering all feedback, the team attended regularly scheduled meetings of the Las Olas Mobility Working Group to provide updates, discuss progress, gather feedback, and provide information to be further distributed to larger stakeholder groups and constituents.

In addition, the team scheduled meetings with HOAs, Business Organizations, Civic Groups, property owners, business owners, churches and individuals and groups who will be directly impacted by the proposed conceptual design. These included meetings with the Fort Lauderdale Downtown Development Authority and its staff and the Executive Director of the Las Olas Association; Colee Hammock, Las Olas Isles, Downtown Fort Lauderdale and other civic associations; members of the first Presbyterian Church; and various business owners such as the Las Olas Company and Barron Real Estate, among others. The team also accepted individual meetings by request and remained open and flexible to meet with any individual or group who had questions and concerns or wanted to share feedback.

At the meetings with the various civic associations, updates to the project and feedback on various iterations were received and communicated back to the project team. These meetings were also used as a venue to ask attendees questions to better understand their concerns as well as qualities of place that impacted their daily lives or those of their neighbors.

## Walking Tours

A series of walking tours were conducted in order to review the existing conditions of the Las Olas Corridor with stakeholder groups, and to collect feedback and input regarding the direction for the proposed conceptual design. The first in-person walking tour was held in February 2020.



Due to the pandemic, in lieu of further in-person tours, the consultant team pivoted to develop a virtual walking tour showcasing the corridor and met with key stakeholder groups virtually in May 2020 to review the existing conditions and collect input. The virtual tour was then made available to the general public via the Las Olas Mobility Working Group webpage.

### Virtual Presentations

In lieu of in-person workshops, the consultant team developed virtual video presentations that detailed the draft and final proposed conceptual design considerations for review and discussion with stakeholders. Scheduled Las Olas Mobility Working Group meetings were used as the platform to review and discuss these presentations, as well as to review the purpose of the study, the scope of services, timeline, and expectations. The interactive virtual meetings also allowed for open discussion, question and answer segments and the ability to collect additional input from



stakeholder groups. In addition to the Las Olas Mobility Working Group members, who were each representing larger stakeholder groups, the consultant team also invited other civic and community interest groups to participate.

Presentations and supporting documentation were then made available to the general public on the Las Olas Mobility Working Group webpage.

### Digital Communications

The Las Olas Mobility Working Group webpage was periodically updated to provide the general public with relevant project documents, presentations, videos, project updates, and other resources. The webpage also listed a project email address through which the general public could provide feedback or questions.

Important project milestones, such as the release of the virtual walking tour and the draft conceptual design documents, were posted through the City's social media pages to notify the public.



# Handout Provided During The Plan Development Process

## The Corridor



## Proposed Conceptual Design Considerations

The vision of the Las Olas Streetscape project is to connect residents and visitors of Fort Lauderdale through the enhancement of the iconic Las Olas Boulevard representing our history and our future. This fact sheet gives a brief synopsis of the proposed conceptual design of the Las Olas Boulevard Streetscape.

### Character Areas

Las Olas passes through five distinct urban character areas, each contributing to the continuous experience and visual identity of the street. These areas - Downtown, The Shops District, Colee Hammock, The Isles, and the Beach - have been studied individually and cohesively to inform the draft conceptual design recommendations.

### Corridor-Wide Considerations

#### Branding and Identity

Consistent design elements throughout the streetscape

#### Safety Improvements

General enhancements for all users including crossings, separated facilities, sight triangle, and traffic improvements, and recommendations for future EMS enhancements

#### Bike Facilities

Separated facilities and parking available throughout the corridor in coordination with new public spaces and transit facility improvements

#### Improvements to Signalized Intersections

Modifications to intersections to address the needs of active transportation at currently signalized intersections

#### Drainage and Climate Change

Roadway changes, drainage improvements, and the addition of absorbent plant life and landscaping to prevent flooding

#### Wayfinding and Landscaping Improvements

Enhancements of signage, shade trees, foliage, land cover, sidewalk, and crosswalk design

### DOWNTOWN

S Andrews Ave. to US-1

Downtown Las Olas is the prestigious address and front door for office and residential development.

#### Current Features and Opportunities:

- Generally pedestrian-friendly with ample shade
- There is a need for bicycle facilities to connect with the emerging adjacent districts and transit

#### Proposed Design Considerations

##### Separated Facilities - Enhanced Safety Through Separation of Traffic Modes

- Protected bicycle facilities - one-way cycle tracks on the north and south sides of Las Olas
- Floating bus stops along the cycle track

##### Improved Curbside Management and Enhanced Crossings in Tandem with Other Improvements

- Sidewalk widths will not be reduced
- Southside parking will be removed for bicycle lanes
- Northside parking will be removed between 3rd and 4th Avenue to extend the westbound turn on 3rd Avenue
- Gateway and wayfinding features at the corner of Las Olas and S Andrews Avenue
- New pedestrian crossing at SE 5th Avenue
- Enhanced crossings at multiple intersections
- Raised intersections and other enhanced conditions to support ADA
- Wayfinding for accessing nearby facilities

### THE SHOPS

US-1 to SE 12th Ave.

The Shops possess a pedestrian scale and an iconic green canopy that support its role as a premier shopping strip.

#### Current Features and Opportunities:

- Pedestrian scale and iconic green canopy
- Narrow sidewalks can create pinch-points where street furniture and landscaping are not well coordinated
- Area is accessible through pedestrian alleys between street blocks and organized parking lots behind storefronts

#### Proposed Design Considerations

##### Curvy, Curbed Streets to Enhance the Quality of the Pedestrian Realm in Support of the Businesses in the Shops District

- "Curvy" alignment alternating side on-street parking
- A new Gateway Plaza at Tunneltop
- Expanded sidewalks for pedestrians
- Provision of amenities to complement businesses
- Raised intersections to support ADA

##### Outdoor Seating - Expansion of Outdoor Seating Options to Support Businesses

- Provision of modular, movable street furniture and landscaping
- Increased outdoor dining space
- Vista opportunity at Himmarshee Canal Bridge

##### Green Canopy - Ample Shading

- Incorporate signature landscaping

##### Festival Space - Design Supports Open Streets Events

- Incorporate design elements to facilitate open street events along the three blocks
- Wayfinding to facilitate alternative routes for drivers and cyclists
- Shared roadway and alternative routes directing bicyclists to SE 2nd Court and SE 4th Street

## Las Olas Streetscape Masterplan

### COLEE HAMMOCK

SE 12th Ave. to Isle of Capri Drive

Colee Hammock is the neighborhood center that caters to residents year-round.

#### Current Features and Opportunities:

- Has both a residential and commercial area
- Challenges in providing enough pedestrian space to support shopping activities
- There is a lack of shade trees
- Bicycle lanes encroach on parked cars and are interrupted at the SE 15th Avenue signalized intersection
- SE 15th Avenue is used as an alternative route for drivers to avoid downtown

#### Proposed Design Considerations

##### Improved Pedestrian Realm - Opportunity to Expand the Pedestrian Area and improve safety

- Expanded sidewalks and street trees along storefronts west of SE 15th Avenue
- Increased outdoor dining space
- Landscape buffers east of SE 15th Avenue
- Landscaped medians to facilitate crossings and communicate changes east of SE 15th Avenue
- A chicane between SE 15th Avenue and SE 13th Avenue offering additional space for public art and gateway feature
- Improved shaded area to enhance walkability
- Recommendation for a full replacement of the Sospiro Canal bridge to add pedestrian and bicycle space while maintaining 4 lanes
- Opportunity for new West Isles green space with a waterfront sightseeing area
- Enhanced crossings at 13th, 15th and 17th Avenues

##### Cycle Tracks - Dedicated Space for Cyclists

- One-way cycle tracks on the north and south

##### Traffic Improvements - Use of Speed Tables, Speed Humps, and Diverters to Encourage Safe Speeds

- Dual left turn at SE 15th Avenue to improve the intersection capacity and overall safety
- Maintaining width of 15th Avenue north of 2nd Court
- Reducing car travel lanes west of SE 15th Avenue
- Speed tables or raised crossings at intersections
- Recommendation for additional traffic studies to review making 16th Avenue a southbound right turn only, and closing 17th Avenue at Las Olas to vehicular traffic

### THE ISLES

SE 17th Ave. to Coral Way

The Isles is primarily residential and possesses a pleasant waterfront experience frequently used by joggers and bicyclists.

#### Current Features and Opportunities:

- Generally pedestrian-friendly with ample shade
- Waterfront locations and great views
- There is a need for bicycle facilities to connect with the emerging adjacent districts and transit

#### Proposed Design Considerations

##### Separated Paths - Area for Strolling and Leisure with Canal Views alongside Efficient Roadways

- Bicycle paths on the north and south
- Median maintained at 12 feet with palm trees
- Four traffic lanes maintained
- Seating in rest areas
- Xeriscaping and landscape improvements in open spaces
- Sidewalk widths are maintained or expanded

##### Traffic Calming - Additions to naturally slow traffic

- Reduced width of traffic lanes
- The addition of plant life and other visual cues

##### Landscaping and Engineering Design - To address flooding

##### Sight Triangle Extensions - Cantilevers at each bridge

##### Pleasant Shade - Expanded Shading Tree Options

##### New Crossings - With Landscaping and Hardscaping to Draw Attention to Pedestrians

### THE BEACH

Terminating at State Road A1A

The Beach is a popular destination for residents and tourists alike.

#### Current Features and Opportunities:

- This is an area for strolling or exercising along the oceanfront
- Crossing this area is difficult for cyclists because the curb lane is shared with motor vehicles

#### Proposed Design Considerations

##### Waterfront Paths - Area for Strolling and Leisure with Canal Views

- Recommendation for the City to activate the space at Merle Fogg Park given the proposed under path
- Cantilever expansion of multi-use path on bridge
- Multi-use path coordinated to reach Las Olas Beach Park, parking garage, and bike trail from the Isles

##### Pleasant Shade - Expanded Tree Shading Options

##### Median Redesign - To Prevent Left Turns from Las Olas Boulevard North onto Birch Road

##### Safe Crossings - Crossings with Landscaping and Hardscaping to Draw Attention to Pedestrians Crossing the Street

- A proper bicycle crossing will ensure safe access to Las Olas Boulevard







# » EXISTING CONDITIONS



## » EXISTING CONDITIONS

### General Corridor Conditions

Las Olas Boulevard from Andrews Avenue to A1A is a 2.4-mile corridor that serves as one of three primary routes to Central Beach/Barrier Island in Fort Lauderdale. It is also a key corridor for the city that contains large office buildings within the Downtown Regional Activity Center, as well as neighborhood scale commercial buildings and residential areas. Las Olas Boulevard has various events throughout the year. The character of the street varies across five distinct areas which vary in width, adjacent land uses and patterns, and cross-sections. The Character Areas are as follows:

- Downtown – Andrews Avenue to SE 6th Avenue/Tunnel Top Plaza
- The Shops – SE 6th Avenue/Tunnel Top Plaza to Himmarshee Canal
- Colee Hammock – Himmarshee Canal to Sospiro Canal
- The Isles – Sospiro Canal to Intracoastal Bridge
- The Beach – Intracoastal Bridge to SR A1A

The available right-of-way varies between each character area, ranging from 60 feet to 133 feet. However, right-of-way constraints vary within each character area as described in their individual sections.

Las Olas Boulevard has varying lane configurations depending on the character area. Currently there are two vehicular travel lanes in each direction of varying widths, with exception of the roadway between SE 10th Terrace and SE 15th Avenue, which has one lane of vehicular travel in each direction. However, in the Shops and Downtown section, on-street parking is permitted in the travel lanes next to the sidewalk between 11am and 3am, essentially reducing available travel lanes to one in each direction during hours when such parking is allowed.

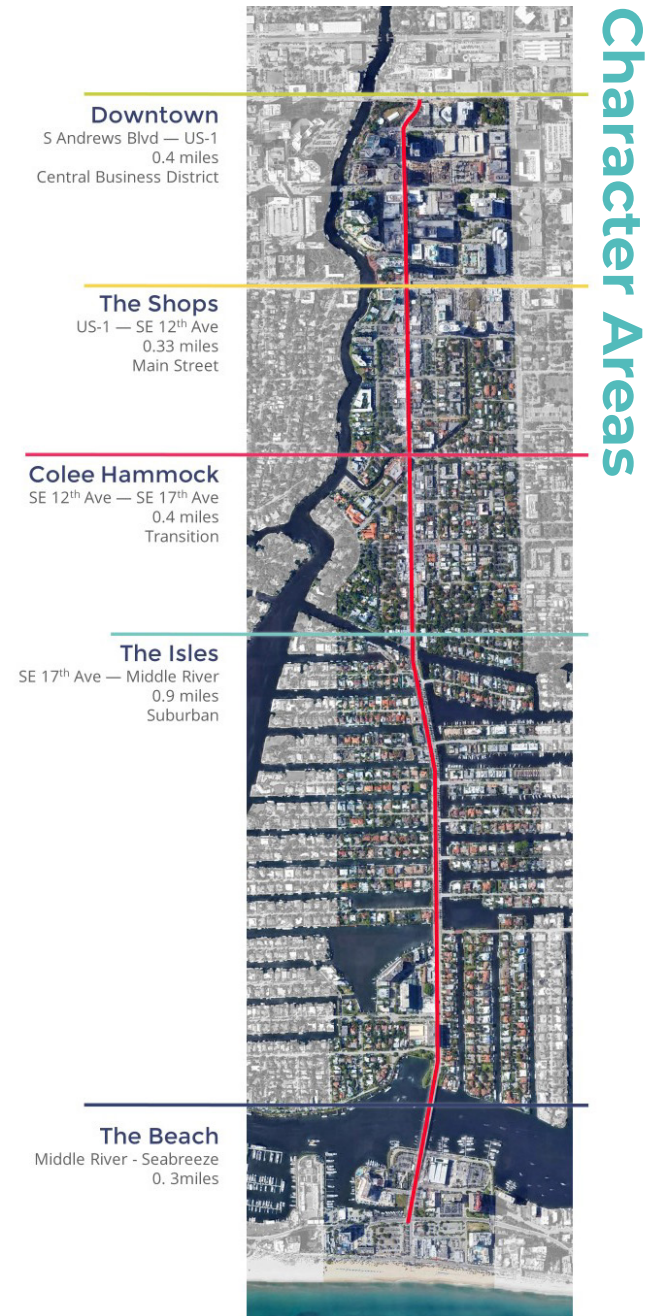



Likewise, bike lane configuration is not consistent along Las Olas Boulevard. West of SE 10th Terrace, bicyclists share the travel lane with vehicular traffic. There is a designated bike lane from SE 10th Terrace to SE 15th Avenue and again from S. Gordon Road to the west end of the bridge over the Intracoastal Waterway. Bicycle lanes are unbuffered outside of Colee Hammock and not continuous along the entire corridor. Across the Intracoastal Bridge to the east, the bicycle lane starts again after crossing the Seabreeze

Boulevard. In areas where there are no bicycle lanes, bicycles navigate through regular traffic.

The entirety of the Corridor is serviced by Broward County Transit, Route 11. The Water Taxi and the City sponsored free Water Trolley are within proximity of Las Olas Boulevard with stops along South Fork of the New River easily accessible from the corridor, such as at SE 9th Avenue.

Sidewalks exist through the corridor, but at varying widths and are detailed further in their respective character areas. However, all of the areas except for the The Shops are greatly lacking in natural shade. Within The Shops area, where the Black Olives are in the median, shade is generally geared toward vehicular traffic and not pedestrians. While there are trees along the entire corridor, the overwhelming majority are palm trees. While the palms keep with the tropical feel of the corridor, they offer little in the way of shade and pedestrian experience.

As a whole, the entire corridor has distinct elements which create a visually haphazard situation. Las Olas Boulevard has over five different types of lightposts, and over eleven different types of hardscape throughout the corridor. The lack of visual identity makes it difficult to present a unified theme for Las Olas.

It is also important to note that while a majority of the tree species currently planted along Las Olas Boulevard are tropical and Florida Friendly™, they will not be appropriately resilient in the future. This is particularly important as various areas of Las Olas Boulevard are currently subject to some form of flooding risk, ranging from pooling in the Downtown area to flooding during King Tide in the Isles and Colee Hammock areas.

## Character Areas Conditions

The following provides for additional details for each character area:

### Downtown

- **General Right-of-Way Width:** 78.5 feet to 80 feet.
- **Pedestrian Facilities:** Sidewalks are wider in the Downtown area, with about 12 feet to 15 feet of sidewalk space between SE 1st Avenue and SE 5th Avenue, and at least 6 feet of sidewalk on both sides west of SE 1st Avenue. All intersections have east-west crosswalks, and north-south crosswalks can be found at Andrews Avenue, SE 1st Avenue, SE 2nd Avenue, SE 3rd Avenue, and SE 4th Avenue. No north-south crosswalk facilities exist at SE 5th Avenue and Las Olas Boulevard, where there are observations of regular pedestrian crossings.
- **Bicycles:** No on-street bicycle facilities exist on Las Olas Boulevard in this area, and bicyclists share vehicular lanes.
- **Vehicular:** This section of the corridor has two vehicular lanes in each direction, at a width of 10 feet per lane. However, as parking is allowed on the lanes adjacent to the sidewalks, between SE 3rd Avenue and SE 5th Avenue, between 11am and 3 am, one lane is generally utilizable for traffic during these hours in that portion of the corridor. As noted in the traffic analysis, the intersection of SE 3rd Avenue and Las Olas Boulevard has heavy congestion, requiring turn lanes. Current construction has resulted in a temporary 4-way Stop controlled intersection at SE 2nd Avenue. The intersection of SE 4th Avenue and Las Olas Boulevard

is raised, and the northbound and southbound lanes at this intersection are right turn only.

- **Landscaping and Street Furnishings:** Virtually every building has its own distinct paving pattern in the right-of-way. The hardscape is made up of multiple shapes and colors of pavers, stamped concrete, and traditional sidewalk, depending on the location. Benches are only found at a single bus stop shelter and at 100 E. Las Olas Boulevard, which recently completed new construction. This new construction has multiple benches, trash cans, and bike racks within the southern pedestrian right-of-way. Trash cans are rare in the Downtown District, and inconsistent in design. City-owned light poles in this segment are simplistic, painted black with a single square light, while their signage is more classic, almost Victorian in style. FDOT owned street lights are white with long arms and round lamps. Privately owned lights vary in style but all are chrome and modern themed.



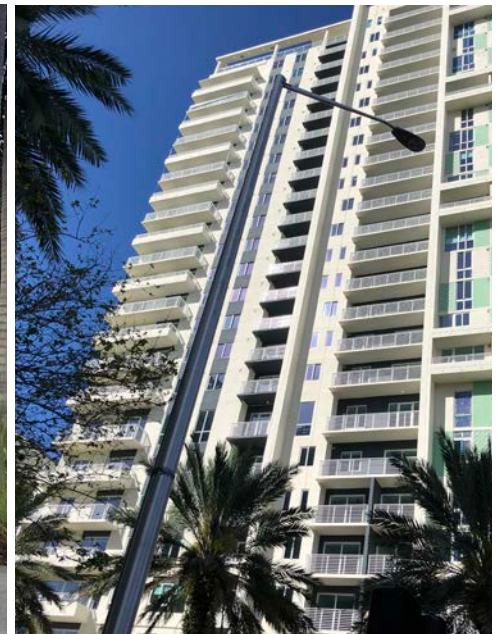



Downtown Existing Conditions between Andrews Avenue and SE 3rd Avenue

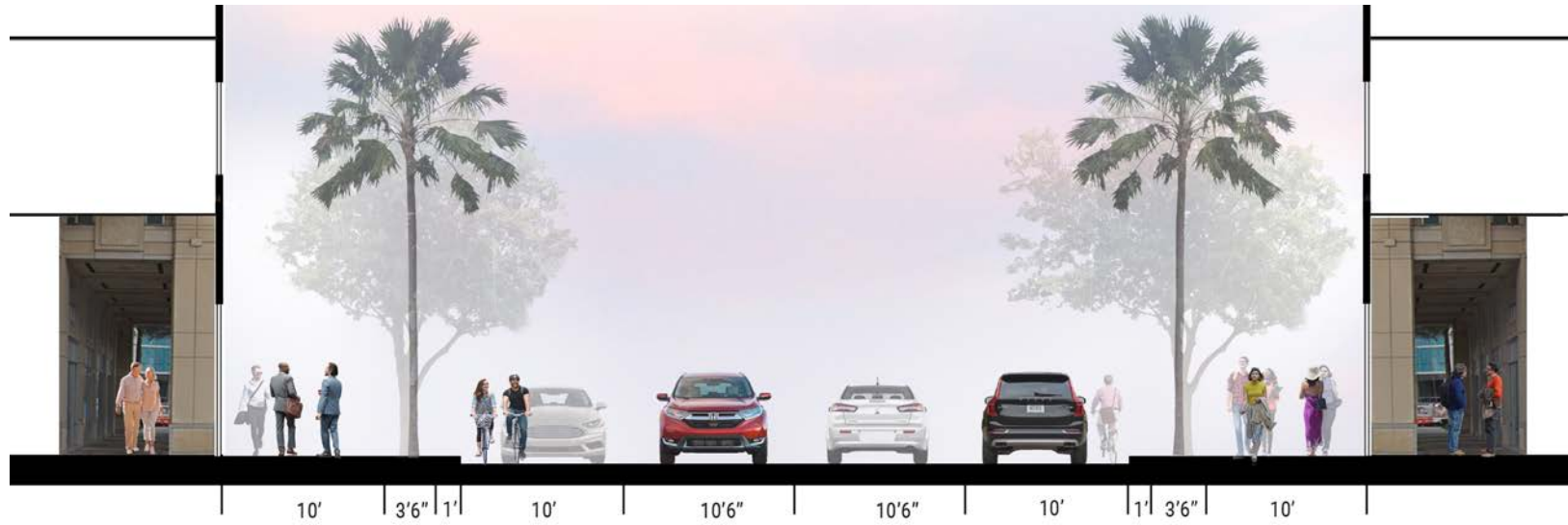

Downtown Existing Conditions between SE 3rd Avenue and Tunnel Top



## The Shops

- **General Right-of-Way Width:** 60 feet.
- **Pedestrian Facilities:** Sidewalks exist on both sides of the street; usable sidewalk space can transition from 15 feet wide to 5 feet or less when paired with cabbage palms. This creates a natural bottleneck where groups must move single file in order to allow movement in both directions. This issue compounds when restaurants put menus out front for passersby to read. Customers take up valuable space while deciding upon where to eat, waiting on a table, etc. Generally, most of the sidewalks between SE 6th Avenue and SE 11th Avenue are pavers with at least 6 feet of available width. However, there are segments, such as by SE 6th Avenue, where the width of the sidewalks are substandard at 4 feet. Crosswalk ramps are misaligned at some intersections, such as SE 9th Avenue and Las Olas Boulevard, and while there are midblock crossings, these crossings are not compliant with the Americans with Disability Act.
- **Bicycles:** No on-street bicycle facilities exist on Las Olas Boulevard in this area, and bicyclists share the lane with vehicles. There is a bikeshare station by the intersection of Las Olas Boulevard and SE 10th Terrace.
- **Vehicular:** This section of the corridor has two vehicular lanes in each direction, at a width of 11 feet per lane. However, as parking is allowed on the lanes adjacent to the sidewalks between 11am and 3am, only one lane is generally utilizable for traffic during these hours.
- **Landscaping and Street Furnishings:** Both the North and South right-of-ways are planted with consistent, evenly spaced cabbage palms in tree pits surrounded

by shrubs. The medians are filled with large black olive trees, whose canopies spread over the traffic lanes to shade the pedestrian right-of-ways. This area is full of temporary structures. Restaurant menus, sale signs, and outdoor seating abound. The menus and signs are commonly directly in the right-of-way, blocking pedestrian traffic. Outdoor seating for restaurants is within their property line. Some businesses have even created their own structures such as wooden seating around an existing cabbage palm.

- **Other Considerations:** The Shops area is frequently utilized for public events, such as Christmas on Las Olas or the Las Olas Art Festival, whereby the area is closed to vehicular traffic.





The Shops Existing Conditions

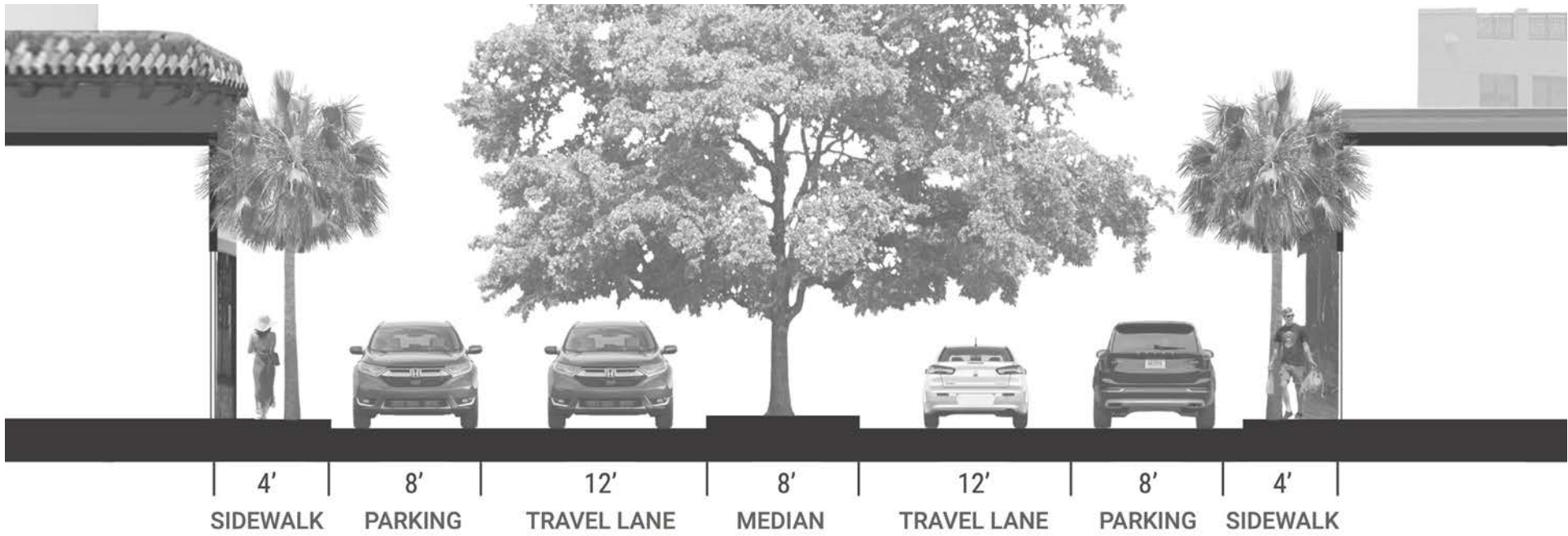



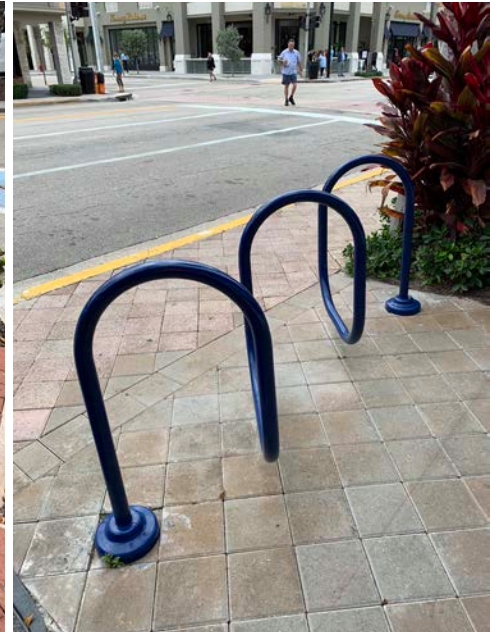

## Colee Hammock

- **General Right-of-Way Width:** 60 feet to 70 feet. Colee Hammock’s available right-of-way on Las Olas Boulevard is unique among the sections in that it is the only area to contract and expand from block to block. The right-of-way is 70 feet between SE 12th Avenue and SE 13th Avenue, 60 feet from SE 13th Avenue to SE 16th Avenue, SE 68 feet from 16th Avenue to 17th Avenue, and 60 feet from 17th Avenue to across Sospiro Bridge.
- **Pedestrian Facilities:** Sidewalks exist on both sides of the street; usable sidewalk space generally is 6 feet, with 2 feet tree wells periodically reducing the effective sidewalk space to 4 feet. North-south crosswalks are located at SE 13th Avenue and at SE 15th Avenue. The north-south crosswalk at SE 13th Avenue has in-ground pedestrian actuated lights.
- **Bicycles:** Generally, 4 feet bicycle lanes exist in this area of Las Olas Boulevard between the Himmarshee Canal Bridge and SE 17th Avenue. At intersections east of SE 15th Avenue and on the south side of Las Olas Boulevard at SE 16th Avenue, the lanes are marked green across the intersections. Various portions of the lanes are buffered by areas marked in blue. Spatial constraints east of SE 15th Avenue gradually narrow the bicycle lanes until they stop at SE 17th Avenue on the south side. On the north side, there is a bicycle lane gap between SE 15th Avenue and SE 16th Avenue.
- **Vehicular:** This section of the corridor has two vehicular lanes in each direction east of SE 15th Avenue, at a width of 11 feet per lane. West of SE 15th Avenue, this changes to one vehicular lane in each direction at a width of 11 feet per lane. The intersection of SE 15th Avenue and

Las Olas Boulevard is congested. The intersection of SE 17th Avenue and Las Olas Boulevard on the southbound leg is right turn only; however, there are sight distance issues at this intersection that negatively impact safety. On-street parking is provided on both sides of Las Olas Boulevard between SE 12th Avenue and SE 15th Avenue (32 spaces), and on the north side between SE 15th Avenue and SE 16th Avenue (8 spaces).

- **Landscaping and Street Furnishings:** Both the north and south right-of-ways are planted with consistent, evenly spaced cabbage palms in tree pits. There are a few benches that can be found outside of businesses and by a driveway on the northern right-of-way. However, these are temporary in nature; benches tend to get brought back into the businesses at closing. This area is the most pedestrian friendly as it has an abundance of sight amenities. Trash and recycling cans are adequately spaced for consistent usage.
- **Other Considerations:** The Himmarshee Canal and Sospiro Canal bridges are both advanced in age. Further, Sospiro Bridge is constrained for expansion by the existing water mains immediately to the north of the bridge, and by available space to the south of the bridge.

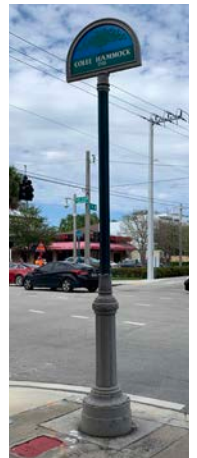

Due to the age of the of the Sospiro Bridge, at about 75 years old, it may be more efficient to engage in a complete reconstruction. Next steps here should be coordination between the City and FDOT to assure the City CIP and FDOT Work Programs are in alignment relative to what needs to be done, cost and timing.

# Colee Hammock Existing Conditions

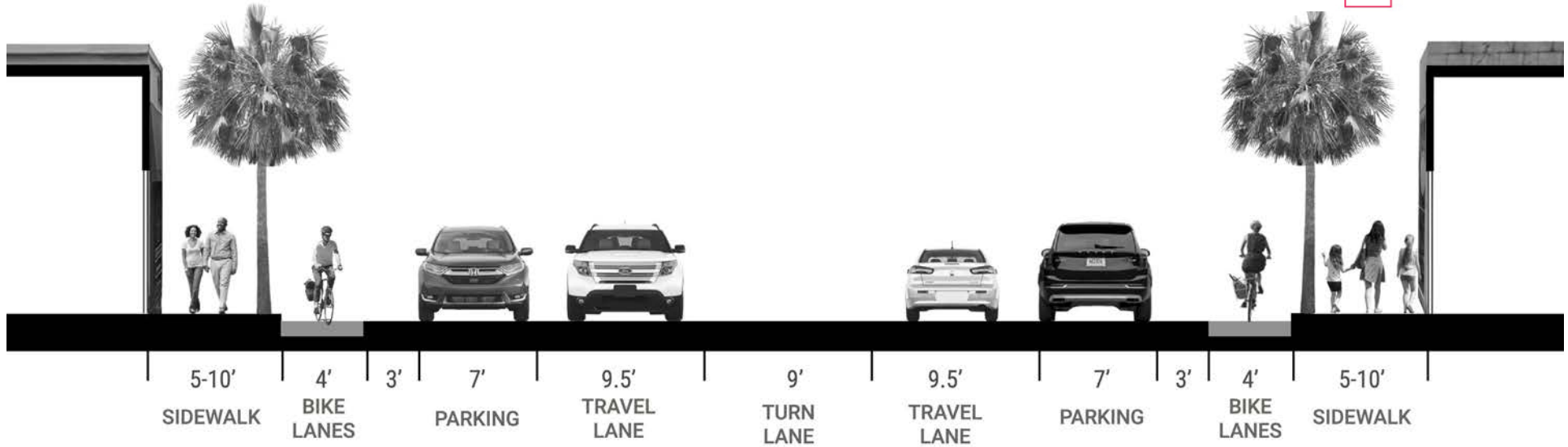



## The Isles

- **General Right-of-Way Width:** 100 feet to 130 feet.
- **Pedestrian Facilities:** Sidewalks exist on both sides of the street; usable sidewalk space generally is 6 feet. The sidewalk on the south side of Las Olas Boulevard between the Marathon Gas station and SE 25th Avenue is constrained by the landscaping, causing “pinch-points” of 3 ft of pedestrian space in front of the retail and restaurant establishments. Between SE 15th Avenue in Colee Hammock and SE 25th Avenue, while there are east-west crosswalks at every intersection, there are no north-south crosswalks. There is also a lack of a north-south crosswalk by Merle Fogg Park.
- **Bicycles:** Generally, bicycle lanes of at least 4 feet exist in this area of Las Olas Boulevard from just east of the Sospiro Bridge to Poinciana Drive on the south side, and Plaza Las Olas on the north side. Neither Sospiro Bridge nor the Intracoastal Waterway Bridge has separate bicycle facilities; bicyclists are expected to utilize vehicular travel lanes (sharrows).
- **Vehicular:** This section of the corridor has two vehicular lanes in each direction, at a general width of 12 feet per lane. Given the configuration of the bridges and intersection setback for the isles on the north side of Las Olas Boulevard, there is a sight distance issue which may impact safety. Speeding, as noted in the traffic analysis, is an issue for this area.
- **Landscaping and Street Furnishings:** The entirety of “The Isles” is planted with palms and has no seating except for the occasional bus stop bench. The lack of shade is evident here and creates a heat island

effect that detracts from the pedestrian experience. In addition, there are several historical markers and structures along the corridor.

- **Other Considerations:** This area is the longest segment of Las Olas Boulevard; however, the character of the area west of Seven Isles Drive has significant differences with the area east of Seven Isles Drive, including available right-of-way and land use.





The Isles Existing Conditions between Sospiro Canal and SE 23rd Avenue

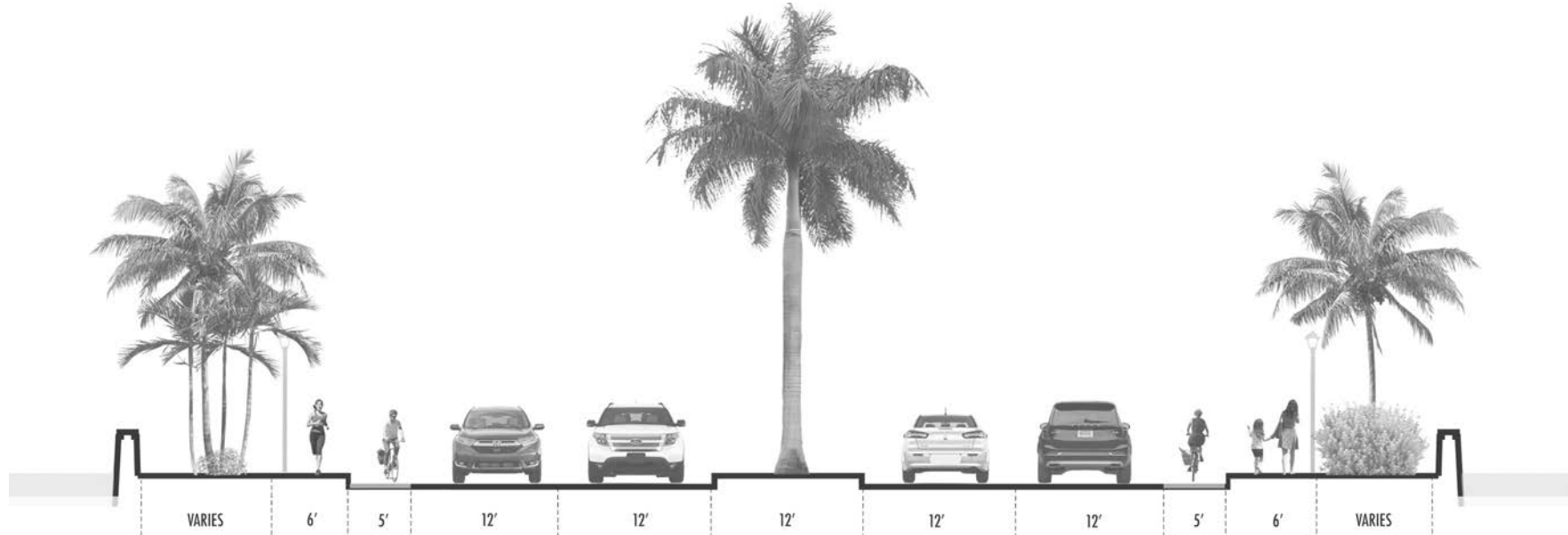

The Isles Existing Conditions between SE 23rd Avenue and Plaza Las Olas

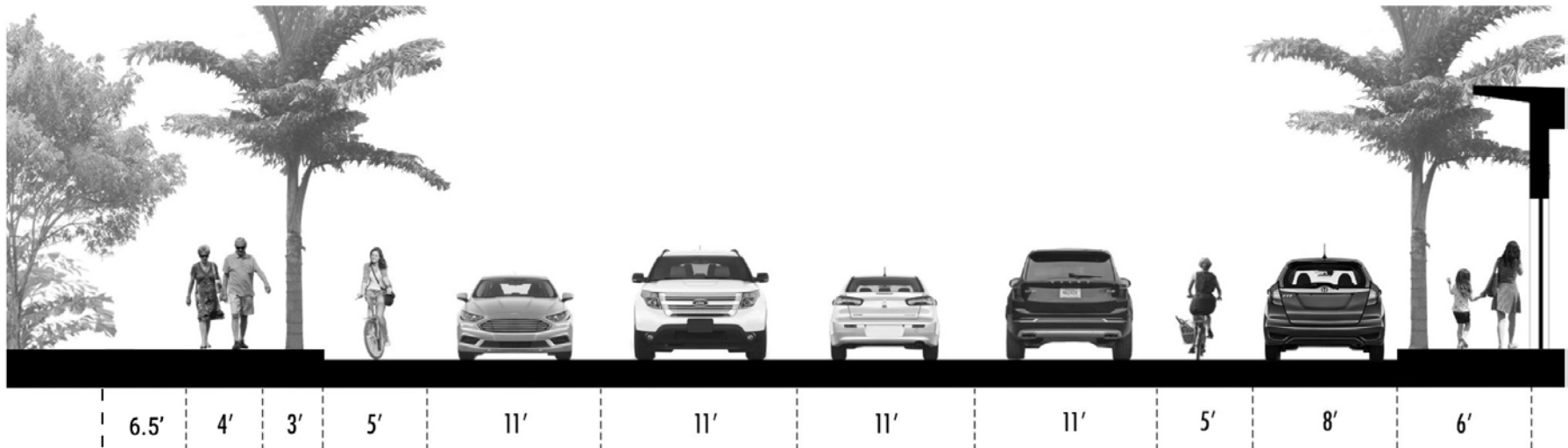

## The Beach

- **General Right-of-Way Width:** 100 feet to 130 feet.
- **Pedestrian Facilities:** Sidewalks on both sides of Las Olas Boulevard are generally at least 6 feet in width and are adequate. However, the pedestrian realm is lacking in shade trees.
- **Bicycles:** 4 feet bicycle lanes exist on the south side of Las Olas Boulevard between Seabreeze Boulevard and S. Fort Lauderdale Beach Boulevard and are marked in green. This connects to the AIA route to the east. Heading west, bicyclists merge into vehicular traffic to share the lane across the Intracoastal Waterway Bridge.
- **Vehicular:** This section of the corridor has two vehicular lanes in each direction, at a width of 11 feet per lane. During prior construction of improvements in the Beach area, the median at the eastern end of the Intracoastal Waterway Bridge, which normally extends beyond Birch Road to Las Olas Circle, was not reconstructed.
- **Landscaping and Street Furnishings:** The Beach area contains seating along Las Olas Oceanside Park. As noted elsewhere, this area has palm trees but is lacking in shade trees. Due to the Las Olas Oceanside Park improvements, the street is curbsless between Seabreeze Boulevard and S. Fort Lauderdale Beach Boulevard, with bollards.

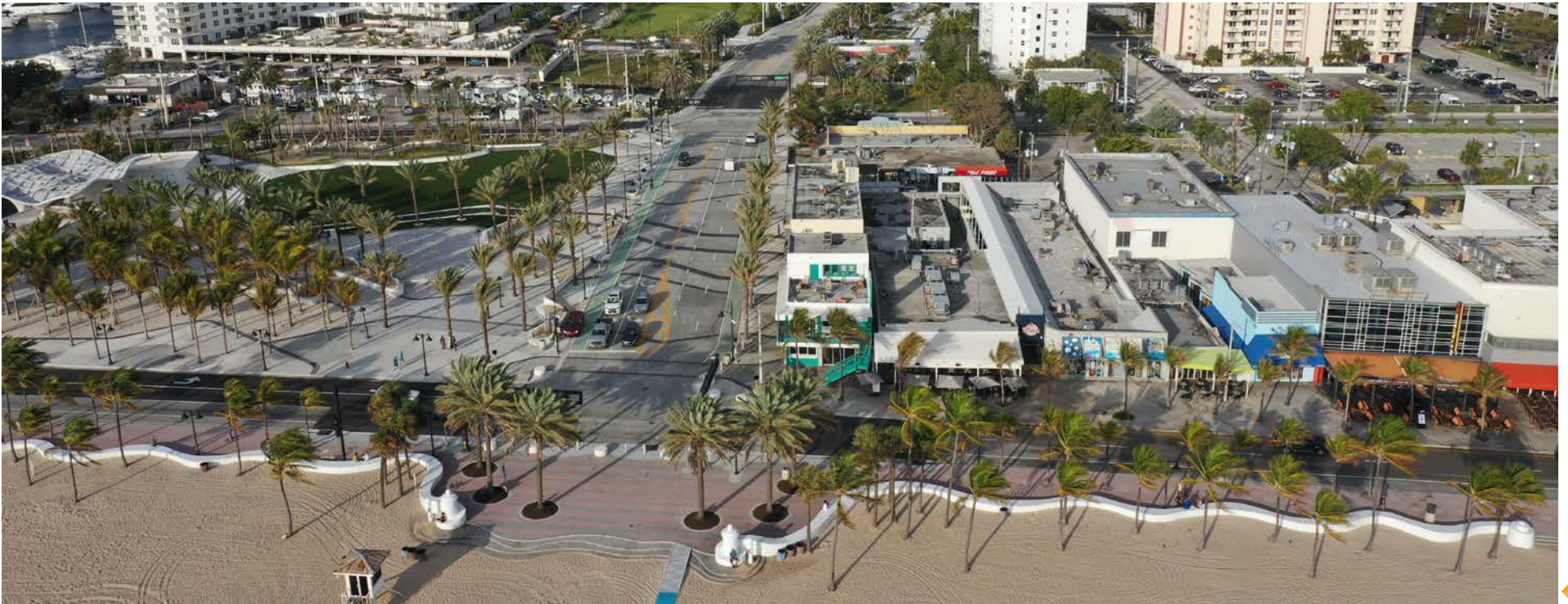









# » OVERALL VISION AND AREA RECOMMENDATIONS



# Character Areas



**Downtown**

S Andrews Blvd — US-1  
0.4 miles  
Central Business District

**The Shops**

US-1 — SE 12<sup>th</sup> Ave  
0.33 miles  
Main Street

**Colee Hammock**

SE 12<sup>th</sup> Ave — SE 17<sup>th</sup> Ave  
0.4 miles  
Transition

**The Isles**

SE 17<sup>th</sup> Ave — Middle River  
0.9 miles  
Suburban

**The Beach**

Middle River - Seabreeze  
0.3 miles

# » OVERALL VISION AND AREA RECOMMENDATIONS

## The Overall Concept

The design of Las Olas Boulevard strives to create a street where residents and visitors feel invited to share company, go for a stroll, and be comfortable in their community.

As the major thoroughfare connecting Downtown Fort Lauderdale and Central Beach, Las Olas Boulevard must balance moving people efficiently through a variety of transportation needs, inclusive of pedestrian, bicycling, vehicular, and transit modes, with space programmed to

safely accommodate alternative modes such as scooters when they are present. Within the context of the network, Las Olas Boulevard is the most direct route between Downtown and the Beach. Its centrality also places it within reach of transit, the Water Taxi, and park facilities. The natural geography of the corridor also offers a number of opportunities for viewpoints and gateway features at transitions, such as connecting with Riverwalk via Tunnel Top Plaza.

Some general opportunities for enhancement were identified throughout the corridor, including: improved comfort with shade trees, cohesive branding, connections to nearby destinations, uninterrupted bicycle facilities, and wayfinding.

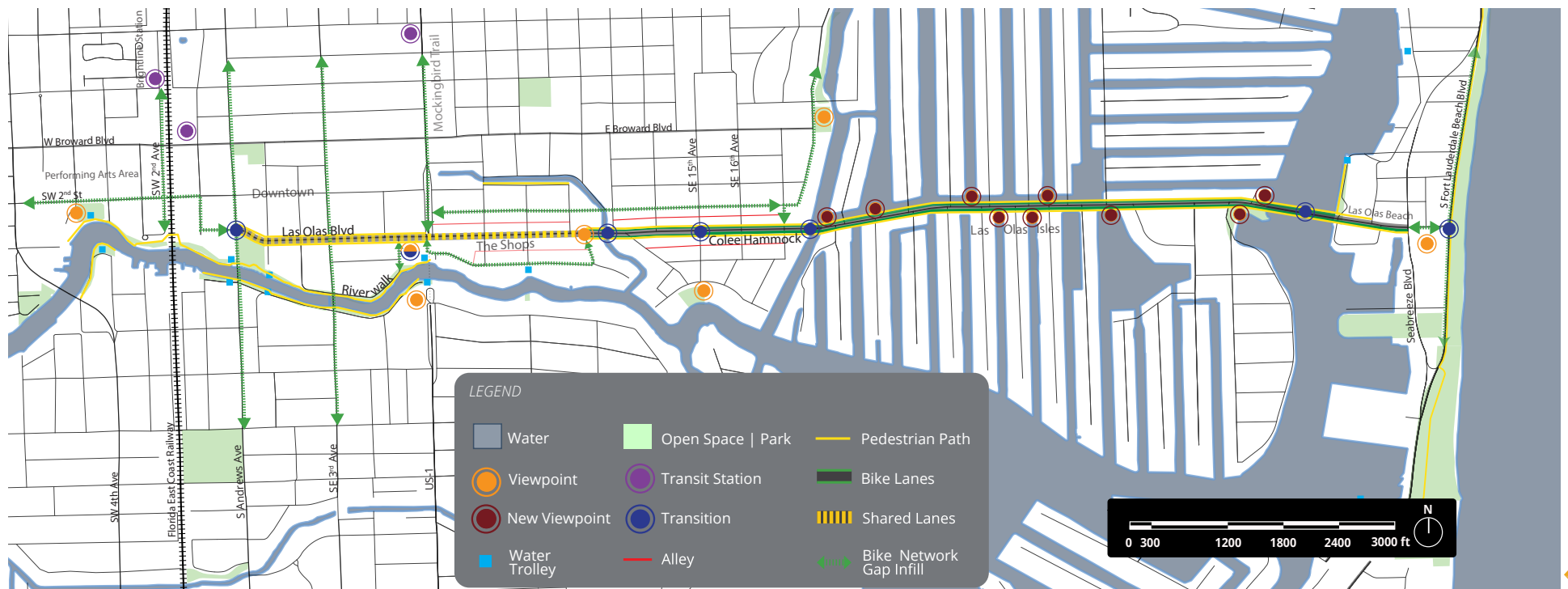

Embracing and creating a street that acknowledges these opportunities will help:

- Emphasize the safety of all users in the design of intersections. Prioritize safety of the most vulnerable users of the street.
- Provide well-designed bicycle facilities to ensure mobility and safety to provide a desirable environment that is comfortable, enriching and which encourages people to prioritize biking as a primary mode of transportation. This includes continuity of pathways to provide better comfort for bicyclists.
- Create streets that are flexible and can accommodate a wide scale and range of activities.
- Ensure the street's design and material components speak to the aspirations, cultural preferences and expectations of the community.

The overall vision involves a strategy that starts by understanding that Las Olas Boulevard is part of a larger city and has to integrate with other areas to become even more successful in the future.

Some general opportunities for enhancing the corridor include:

1. A cohesive landscaping strategy that protects pedestrians from the elements of the sun.
2. Improve the overall connectivity of the street network to enhance the mobility of pedestrians, bicyclists, transit users, and drivers.

3. Highlight the presence of pedestrians and cyclists while reducing the speed differential between modes of transportation, and improvements in line with Americans for Disabilities Act to facilitate a safer and more accessible environment.
4. Singular branding to aid in wayfinding to and from the corridor to nearby intermodal transportation facilities, as well as communicating alternative routes to help drivers avoid getting stuck in traffic.

Each segment within this corridor is different but contribute to the continuous experience and visual identity of the street. Through discussions, the identity of each area was brought forward:

- 1. Downtown.** This section of Las Olas will remain the prestigious address and front door for office and residential development that it aims to be. The streetscape of this area should support a walkable downtown with ample shade and seating, with considerations for how the corridor can create connections to the Riverwalk, Brightline, and SW 2nd Street at the edge of the Downtown area.
- 2. The Shops.** This area is iconic today and will be iconic in the future. The environment will be redesigned to prioritize pedestrians and maintain a Main Street charm that serves as the core of its identity today. Sidewalks will be greatly widened and vehicular lanes will narrow, with trees realigned to shade people, not cars. Landscaping, lighting and street furniture will support easy pedestrian walks and unify the district at night. The area will be designed to allow the street to be a place to hold festivals, and support future business development.

**3. Colee Hammock.** This section has the potential to be the neighborhood center that caters to residents year-round. It must be treated delicately. Colee Hammock is the key transition area from the Beach and Isles to the busier Historic Shops and Downtown portions of the Corridor. Colee Hammock is bisected by SE 15th Avenue, and acts as an extension of the corridor in the larger Broward Boulevard, Las Olas Boulevard system. Preservation of this neighborhood's character and quality of life is wholly dependent on how this traffic is handled. Wider sidewalks, secure bicycle paths and flowering trees will create an inviting, aesthetically pleasing neighborhood street that will bring value to the surrounding residences. To support the small businesses that serve the neighborhood, the redesigned streetscape will include areas of outdoor seating for the restaurants and cafés that line Las Olas Boulevard.

**4. The Isles.** The Isles remains a key portion of the corridor that should provide a relaxing walk with ample shade for the residents of the Isles and travelers en route to the beach. Due to the nature of the road here, as a transportation conduit encouraging higher speed driving, it is critical that any plan acknowledge there needs to be a clear separation between vehicles and bicycles and pedestrians. Traffic flow must be designed to allow residents to access their homes and for beachgoers to access the beach. Pedestrian and bicycle paths are safely buffered and have multiple stopping points along this long walk. Improved landscaping, integrated resiliency in design for drainage and improved emergency response times are a must for this neighborhood.

**5. The Beach.** The Beach serves as a destination and a gathering point at one end of the corridor. While the Beach area was planned by itself, the implementation of the Las Olas Oceanside Park and associated streetscape improvements creates a need to better connect this area with the rest of the corridor. Connections to other paths (such as A1A bicycle pathways) may be enhanced by bridging new connections over the Intracoastal Waterways, while unity of design may be achieved through adopting similar landscaping and wayfinding to present one unified concept for Las Olas.



## Principles

For each area, we applied the following principles in considering the recommendations for the future streetscape of each area.

### Pedestrian Safety and Comfort

- Provide universal access and well-designed pedestrian facilities to ensure not just a bare minimum level of safety, but also a desirable environment that is comfortable, enriching and encourages people to prioritize walking as a primary mode of transportation.

### Social Gathering

- Ensure that areas of social gatherings, including events and programs, have optimum level of safety, comfort and convenience.
  - ◆ Implement street-calming features to reduce traffic speed to help create the right environment for social gathering.
  - ◆ Increase useable public space for pedestrians.
  - ◆ Create streets that have a strong pedestrian scale and character.
  - ◆ Create streets that are flexible and can accommodate a wide scale and range of activities.

### Sidewalks and Crosswalks

- Sidewalks play a vital role in city life. As conduits for pedestrian movement and access, they enhance connectivity and



promote walking. As public spaces, sidewalks serve as the front steps to the city, activating streets socially and economically. Safe, accessible, and well-maintained sidewalks are a fundamental and necessary investment for cities, and have been found to enhance general public health and maximize social capital.

- Crosswalks are vital connectors for sidewalks, and generally within the corridor, enhanced crosswalks, including in-ground lights, beacons, and paint are necessary. In some areas, the intersection should be raised and/or patterned to slow traffic down.

### Vehicular Circulation and Controls

- Ensure Mobility and Access - Improve the overall connectivity of the street network to enhance the mobility of pedestrians, bicyclists, transit users, automobile drivers and emergency providers.
- Calm traffic to a desired speed that respects all modes of travel.
- Emphasize the safety of all users in the design of intersections. Prioritize safety of the most vulnerable users of the street.
- Use signals, signal timing and operations techniques to improve mobility and safety of all users.
- Design local and low-volume streets for shared space that is accessible to both pedestrians and vehicles, and to allow pedestrians to move more freely within the entire right-of-way of the street.
  - ◆ Utilize speed control devices such as neckdowns, speed tables, and others to enhance safety.

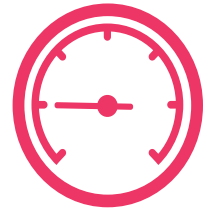



- Design streets to be flexible to accommodate changes (size, turning radius, propulsion, etc) in the existing modes of travel (automobile, public transit vehicles, bicycles, etc.).

- Las Olas is geographically important for the development of a bicycle network within Fort Lauderdale and continuous pathways should be implemented where possible.



## Bicycle Network

- Provide well-designed bicycle facilities to enhance mobility, to create a desirable environment that is comfortable, enriching, and encourages people to prioritize biking as a primary mode of transportation.

## Image and Identity

- Ensure the street's design and material components speak to the aspirations, cultural preferences and expectations of the community.

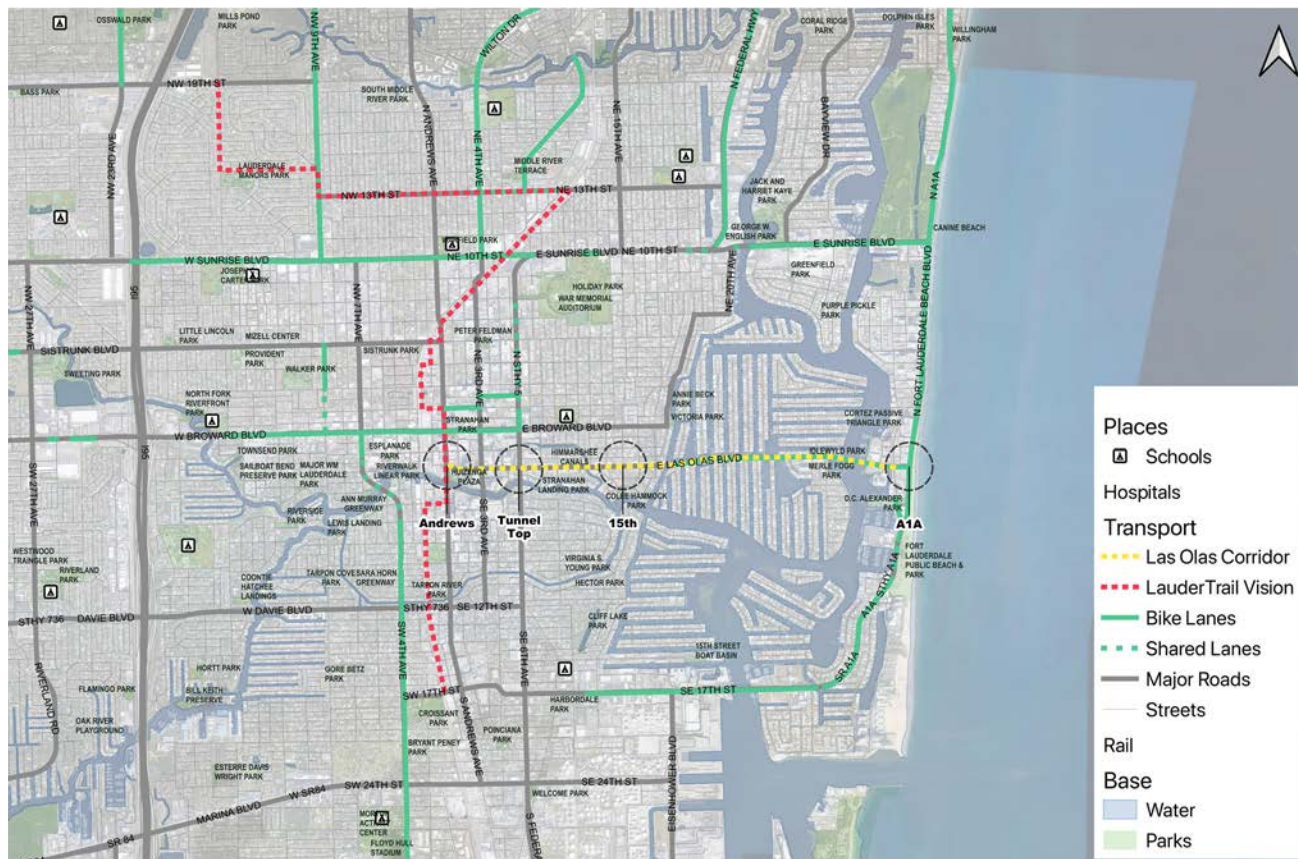



- Use streetscape design that captures the unique history of the region.
- Ensure that iconic streets are well-connected and easily accessible to all users.
- Emphasize and celebrate an iconic street’s location and layout in the overall network of roads of the city, town or surrounding region.
- Program the street to encourage a 24/7 environment, including active daytime use and vibrant nightlife and weekend times.

## Stormwater Management

Stormwater management is a critical element that must be addressed. While outside the area of this study, through discussions with stakeholders, it is clear that this consideration of resiliency and future subsurface work will

affect the utilization of the corridor as a transportation corridor and should be coordinated with the streetscape improvements. Facility design must account for the physical constraints of the site, the presence of subsurface utilities, the local climate, and the feasibility of maintenance agreements.

Sustainable stormwater management aims to achieve the following goals:

- 1. Improve water quality.** Vegetated strips and swales filter and reduce sediment and filter pollutants through settling, physical filtration in the soil matrix, biological breakdown by microbes, and nutrient uptake by plants.
- 2. Detain stormwater flows.** Stormwater runoff is detained in facilities such as flow-through planters, pervious pavements, and bioswales. Detaining the flows mitigates the peak flow rates from the rain event, which in turn helps reduce erosion, loss of nutrients, scouring, and load-carrying capacity.
- 3. Reduce stormwater volumes.** Overall stormwater runoff volumes may be reduced by designing facilities that absorb and infiltrate rain water in place. Water-tolerant plant root systems maintain the porosity of the soil while taking up excess water in the stormwater facility.
- 4. Relieve burden on municipal waste systems.** Sustainable stormwater systems reduce the amount of stress on a city’s wastewater treatment facilities, and may reduce long-term costs if applied at a citywide scale. Unlike traditional infrastructure, which does not add any additional value beyond its stormwater conveyance function, green infrastructure can be incorporated into neighborhood parks and landscaping.

# » Colee Hammock

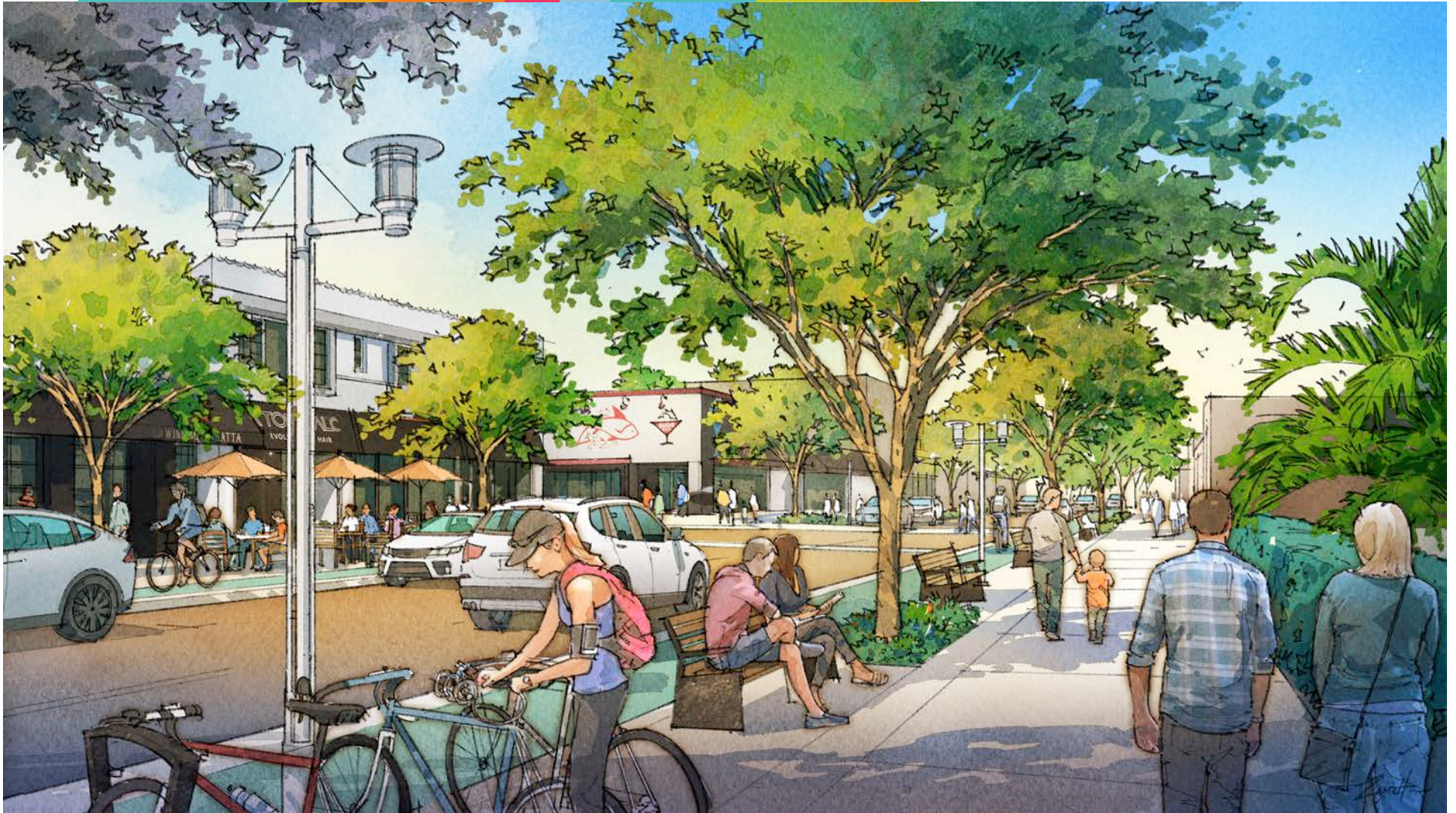

Colee Hammock is reached upon crossing the Himmarshee Canal. This character area extends from SE 12th Avenue to Isle of Capri Drive.

Here, Las Olas has the characteristics of a small town Main Street as Las Olas Boulevard transitions from the urban core to the Beach. Colee Hammock experiences challenges in providing enough pedestrian space to support shopping activities, while also lacking shade trees. As bicycle lanes encroach on the “door zone” of parked cars and are interrupted at the SE 15th Avenue signalized intersection, it is vital that the future of Colee Hammock consider the need for safe, continuous paths.

As a transition between the suburban, car-oriented Isles and the pedestrian-oriented Downtown area of Fort Lauderdale, Colee Hammock must provide design cues to change travel behavior to support a pedestrian-friendly environment for businesses.



Colee Hammock’s residents note cut-through traffic as a major concern. Drivers that seek to avoid driving through Downtown use Broward Boulevard to the north via SE 15th Avenue.

### Recommendations

Colee Hammock should be improved with sidewalk-level, one-way cycle tracks, as well as expanded sidewalks and street trees. By reducing the number of lanes for cars through Colee Hammock, space can be created for people walking and cycling, as well as for shade trees. This redesign will provide shorter crossings and opportunities to include business amenities.

Within Colee Hammock, both the east and west sides of the SE 15th Avenue shops embrace color. The species chosen bring vibrant reds, yellows, pinks, and whites to the segment while providing shade throughout. The color accentuates the various building facades and signage found along this segment. Trees are more prevalent to the west while palms make up a large space in the east. This is to enhance the transition from The Shops to the west and The Isles to the east, respectively.

Safety will also be improved with speed tables or raised crossings at intersections of SE 12th Avenue and SE 13th Avenue. Crosswalks in this area should be enhanced, and sidewalks widened. Protected bicycle lanes should be added.

Overall, east of SE 15th Avenue, the roadway section will retain two lanes in each direction, sidewalks, and bicycle lanes.

The Sospiro Bridge can act as a bottle neck for pedestrian and bicycle flow. The bridge is built in three pieces, two of them, comprising the substructure that holds it up, were built in 1946, so effectively the bridge is 75 years old. While the bridge could be repaired to better accommodate pedestrians and cyclists, it may be most efficient and effective to undertake a full replacement, given the size of the Las Olas project in total. This is a practical decision that needs to be carefully considered by the City in partnership with FDOT.

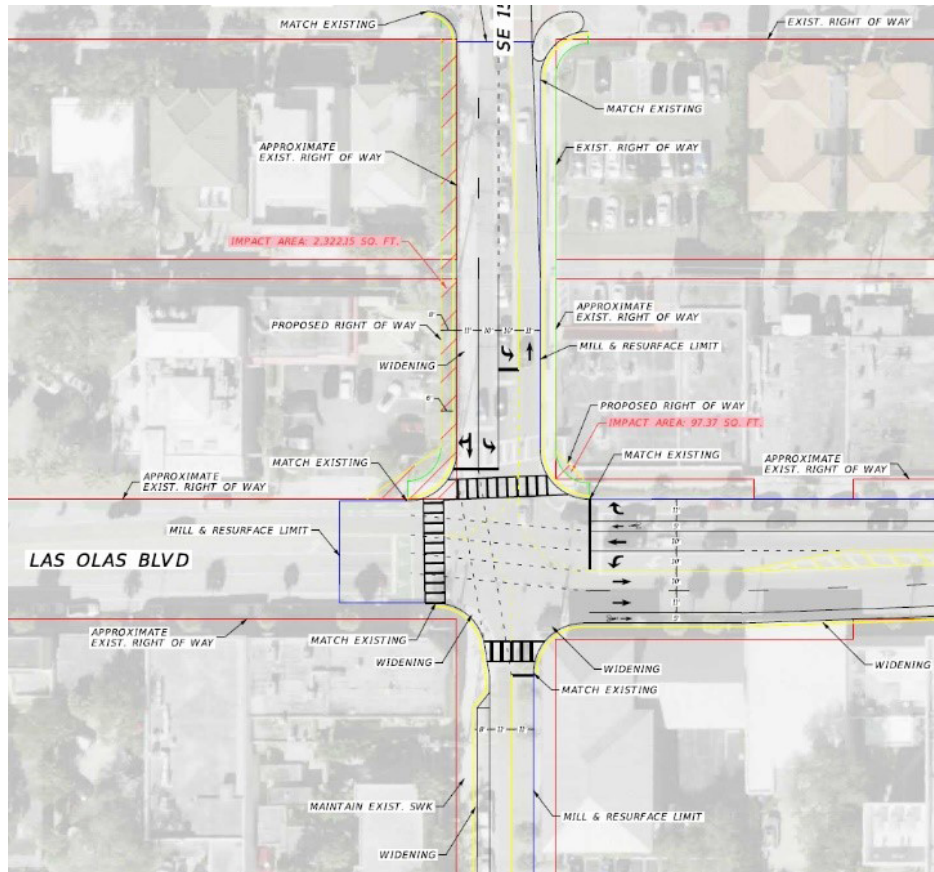

Generally, within this section of the corridor:

**1. Vehicular travel lanes:**

- a. East of SE 15th Avenue:
  - i. Two lanes in each direction.
  - ii. Inside lane at 10'. Outside lane at 11'.
- b. West of SE 15th Avenue:
  - i. One lane in each direction at 11'.
- c. Parking: Retain parking on north side.
- d. Cut-through traffic headed towards Victoria Park should be reduced.
- e. Intersection Improvements:
  - i. Las Olas Boulevard/SE 15th Avenue: Dual-Left option is recommended for this intersection. Must be paired with coordinated improvements at SE 15th Avenue and Broward Boulevard. As Broward County is currently undertaking improvements to that intersection, utilizing federal grants, it is recommended that the City continue to coordinate with the County to pair the improvements at both intersections.
  - ii. Las Olas Boulevard/SE 13th Avenue should remain right-turn only southbound onto Las Olas.
  - iii. Las Olas Boulevard/SE 12th Avenue and Las Olas Boulevard/ SE 13th Avenue will have raised intersections/speed tables.
  - iv. Las Olas Boulevard and SE 16th Avenue: Additional study to determine future traffic operations at this intersection.
  - v. Las Olas Boulevard and SE 17th Avenue: Full closure to vehicular traffic, but retain design to allow for bicycle and pedestrian traffic.

**2. Sidewalks:**

- a. West and East of SE 15th Avenue: Generally at 11'-16' of sidewalk space on both sides.
- b. Crosswalk enhancements, including at SE 12th Avenue, SE 13th Avenue, and SE 15th Avenue.

**3. Bicycle Lanes:**

- a. West of SE 15th Avenue: 5' bicycle lane with a 2' curb separating from traffic.
- b. East of SE 15th Avenue: generally at 4' bicycle lane, with buffer where possible.

**4. Wayfinding and Landscaping:**

- a. The species on both the east and west sides of Colee Hammock should be of vibrant colors, while providing shade throughout.
- b. Canopy trees should be more prevalent to the west, while palms should make up the majority of the plantings in the eastern portion of the district.
- c. The western half of Colee Hammock, from the Himmarshee Canal to SE 15th Avenue, should maintain the look and feel of The Shops as a transition area. Western Colee Hammock includes many restaurants and shops. As this side is "pedestrian heavy", the landscaping should focus on shaded areas. Palms should be used at intersections and to accentuate gateways to the corridor.
- d. The eastern half of Colee Hammock should be planted as a gateway to The Isles. Between SE 15th and SE 16th Avenues, the proposed landscape should match that of western Colee Hammock. East of SE 16th Avenue, the shade trees should gradually transition to a mix of tall palms, such as Cabbage and Alexander Palms, and small accent trees.

- e. Hardscape area as noted in the wayfinding and other sections of this plan features the words "Meet Me @ Las Olas" and acts as the starting point of the flowing hardscape design/pattern seen throughout the entirety of Las Olas Boulevard.

**5. Bridges:**

- a. Himmarshee Canal Bridge:
  - i. Vehicular Travel Lanes: 1 travel lane in each direction: 11' lanes
  - ii. Sidewalks: 6' width sidewalks
  - iii. Bicycle: 5' bicycle lane with a 2' barrier
- b. Sospiro Bridge: Due to the age of the existing bridge over Sospiro Canal, full bridge replacement is recommended, with:
  - i. Separated bicycle lanes at least 4' wide on each side. If possible, the bicycle lanes should be separated from traffic, either with a 3' marking buffer or a curb separation.
  - ii. At least 6' wide sidewalks on each side.
  - iii. Vehicular travel lanes – the outside lane in each direction at 11', the inside lane in each direction at 10'. The vehicular travel lanes should be two lanes in each direction.
  - iv. It should be noted that this bridge replacement may necessitate the movement of water pipes to the north, or minor acquisition of property to the south of the existing bridge.

## Sospiro Bridge

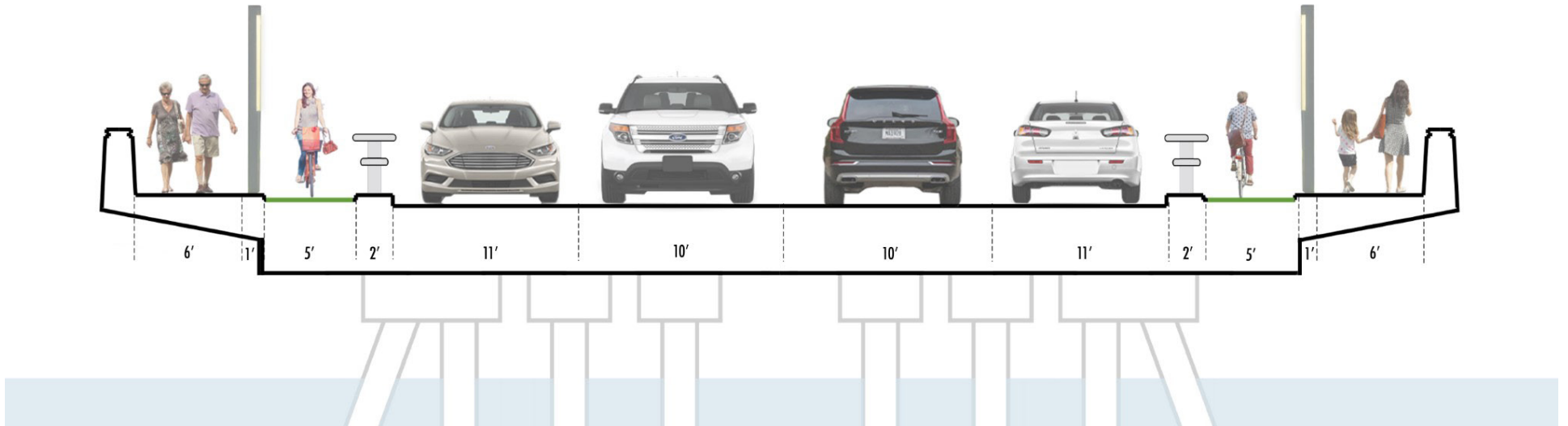



**Street Trees**  
Throughout Colee  
Hammock

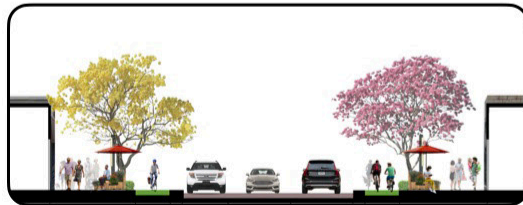

**Proposed Street Section**



**Parallel  
Parking**

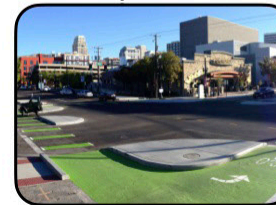

**Protected Bicycle  
Intersection**

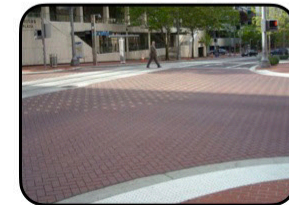

**Stamped Concrete  
Crossings**





New Crossing



Expand Sidewalks

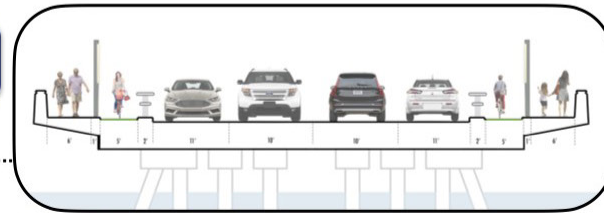

Concept for Sospiro Bridge Improvements

**LEGEND**

- NO CHANGE
- MINOR CHANGE
  1. Additional Turn Lane
  2. Study to evaluate Closed Southbound Exit

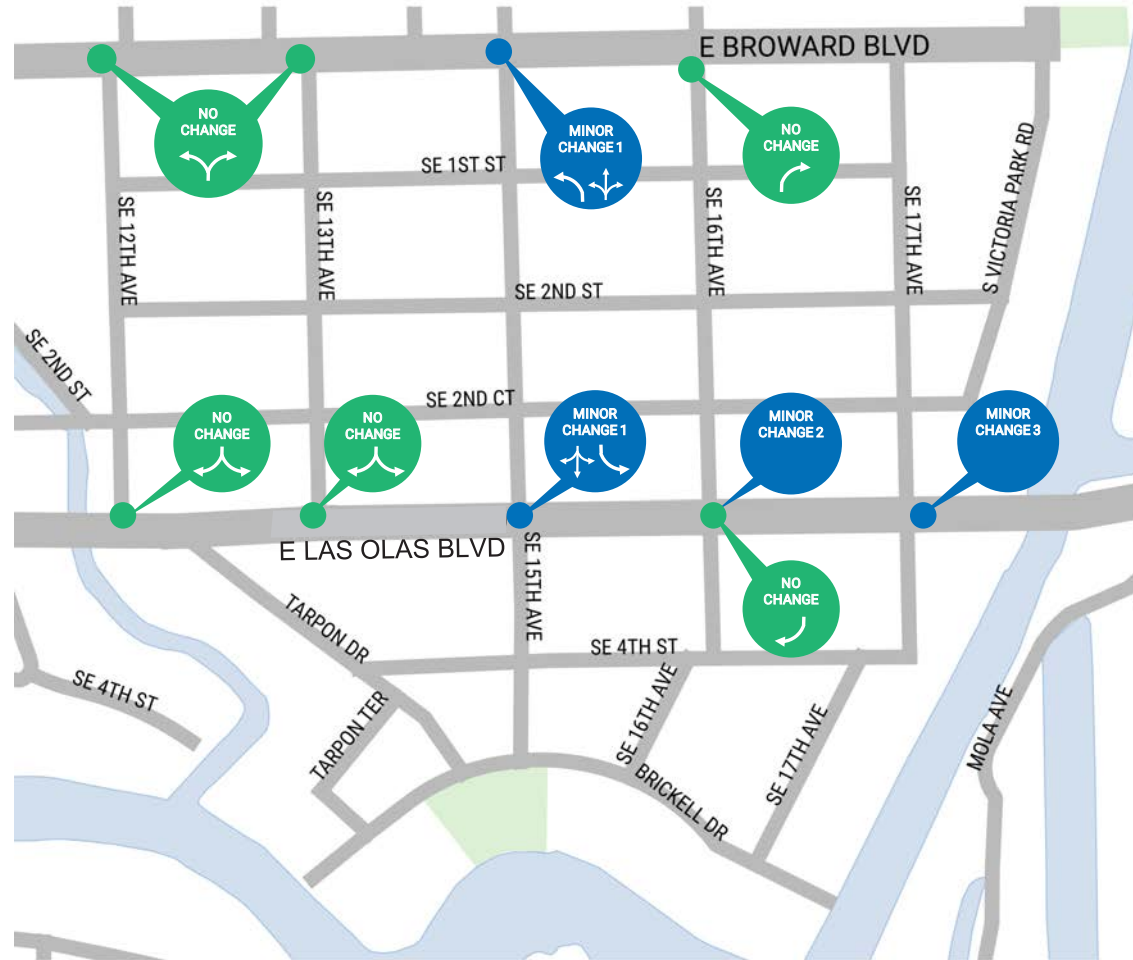

# Colee Hammock Traffic Summary

### Colee Hammock Existing Section between SE 12th Avenue and SE 15th Avenue

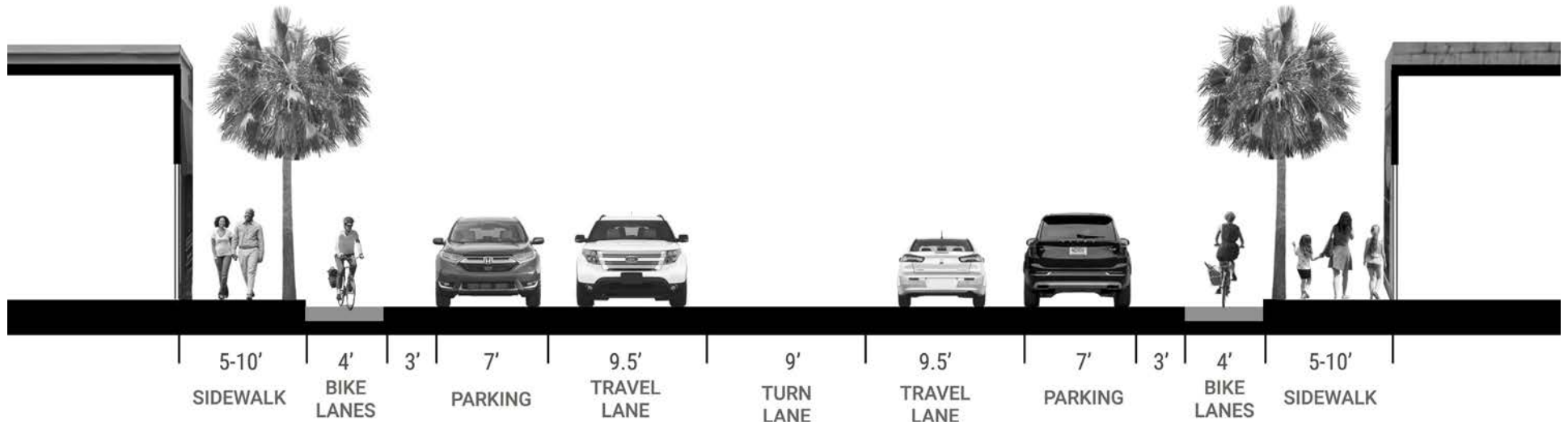

### Colee Hammock Proposed Section between SE 12th Avenue and SE 15th Avenue

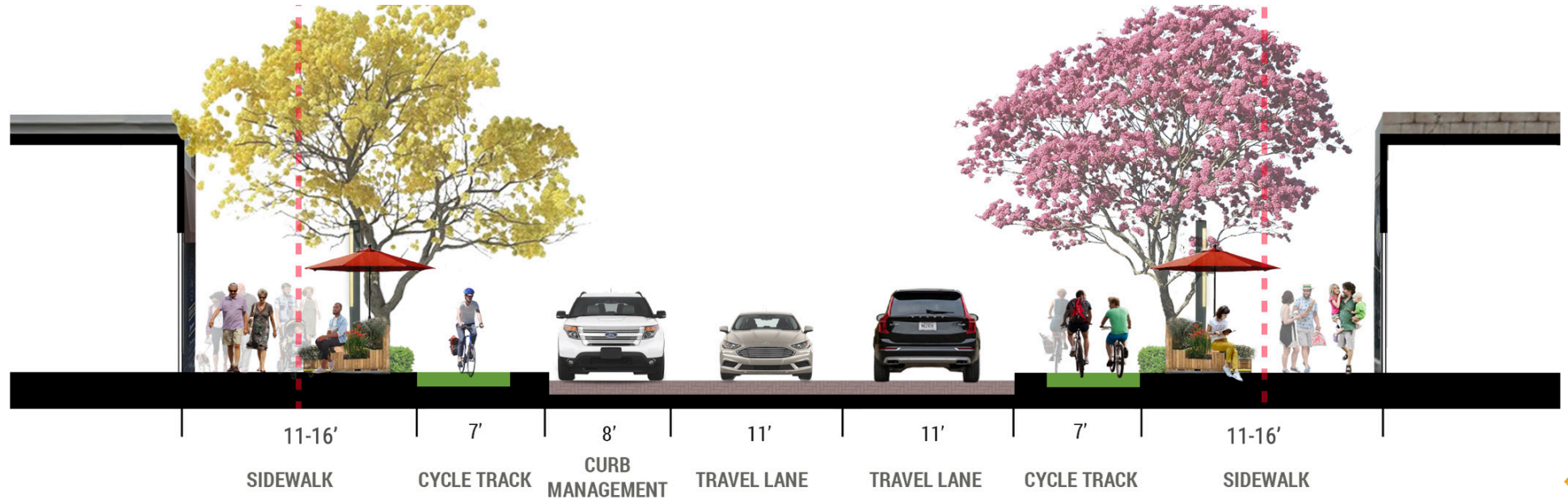

The following provides for the recommended plant palette for the Colee Hammock area.

**Large Trees**



*Quercus Virginiana*  
**Live Oak\***



*Bursera simaruba*  
**Gumbo Limbo\***

**Flowering Trees/Accents**



*Handroanthus impetiginosus*  
**Purple Trumpet**



*Handroanthus heptaphyllus*  
**Pink Trumpet**



*Piscidia Piscipula*  
**Jamaican Dogwood**



**Medium Trees**



*Eugenia foetida*  
**Spanish Stopper\***



*Myrcanthes fragrans*  
**Simpson Stopper\***



*Ardisia ecallanoides*  
**Marlberry**



*Handroanthus chrysotricha*  
**Yellow Trumpet**



*Bulnesia arborea*  
**Verawood**

**Small Trees**



*Conocarpus erectus var. sericeus*  
**Silver Buttonwood\***



*Lagerstroemia spp.*  
**Crepe Myrtle**

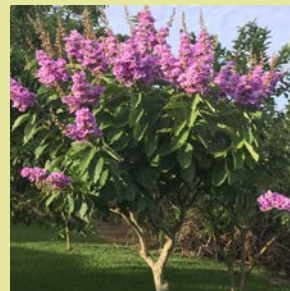

*Lagerstroemia speciosa.*  
**Queen Crepe Myrtle**

**Note: Queen Crepe Myrtle  
only recommended for area  
West of 15th Avenue**

### Large Palms



*Sabal palmetto*  
**Cabbage Palm\***



*Archontophoenix alexandrae*  
**Alexander Palm**

### Small Palms



*Thrinax radiata*  
**Florida Thatch Palm\***

### Shrubs



*Conocarpus erectus*  
**Green Buttonwood\***



*Clusia nana*  
**Dwarf Clusia**

### Medium Palms



*Psuedophoenix sargentii*  
**Buccaneer Palm\***



*Coccothrinax argentata*  
**Silver Palm**



*Chrysobalanus icaco*  
**Cocoplum "red tip"\***



*Ficus microcarpa*  
**Green Island Ficus**



*Bougainvillea spp.*  
**Bougainvillea**



*Hamelia patens var. glabra*  
**Dwarf Firebush\***

### Vines

Vines are very beneficial to a project's planting palette. They soften hardscapes, reduce heat, attract pollinators, and form stunning living screens, especially while flowering. The various species will be utilized in the shade structures throughout the corridor. Vines can be separated into four basic types based on their climbing habits: Clinging, Twining, Sprawling, and Tendril Climbing.



SPECIES	NATIVE	IRRIGATION NEEDS	LIGHT REQUIREMENTS	CLIMBING HABIT	FLOWER COLOR	FLOWERING SEASON
<i>Passiflora incarnata</i> - Passion Flower	Yes	Low	Full Sun	Tendril Climbing	White & Purple	Spring - Summer
<i>Gelsemium sempervirens</i> - Yellow jessamine	Yes	Moderate	Full Sun - Part Shade	Twining	Yellow	Winter-Spring
<i>Campsis radicans</i> - Trumpet creeper	Yes	Low	Full sun -Shade	Clinging Roots	Orange - Red	Spring - Summer
<i>Bougainvillea spp.</i> - Bougainvillea	No	Low	Full Sun	Twining	Red, Pink, Orange	All Year
<i>Allamanda cathartica</i> - Golden Trumpet	No	Moderate	Full Sun	Sprawling	Yellow	Warm Months
<i>Trachelospermum jasminoides</i> - Star Jasmine	No	Moderate	Full sun -Shade	Twining	White	Spring
<i>Bignonia capreolata</i> - Crossvine	Yes	Low	Full Sun - Part Shade	Tendril Climbing	Orange - Red	Spring
<i>Lonicera sempervirens</i> - Coral Honeysuckle	Yes	Low	Full Sun - Part Shade	Twining	Orange - Red	Spring- Fall



*Passiflora incarnata*  
**Passion Flower\***

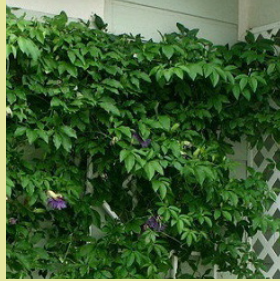

*Bougainvillea* spp.  
**Bougainvillea**



*Bignonia capreolata*  
**Crossvine\***



*Gelsemium sempervirens*  
**Yellow Jessamine\***



*Allamanda cathartica*  
**Golden Trumpet**



*Lonicera sempervirens*  
**Coral Honeysuckle\***



*Campsis radicans*  
**Trumpet Creeper\***

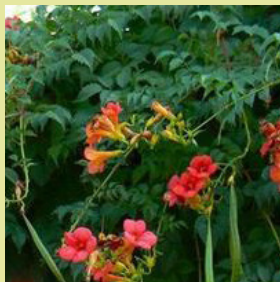

*Trachelospermum jasminoides*  
**Star Jasmine**



# »The Isles





Las Olas in The Isles district has a pleasant waterfront experience and is frequently used by joggers and people on bicycles. In this area, Las Olas Boulevard serves as a direct route between Downtown Fort Lauderdale and Fort Lauderdale Beach. It is also the area of the corridor where there is no alternative pathway for local access. There are ample opportunities to support this highly-residential area with green space to enhance the beauty of the corridor, and while both the Downtown and Beach areas have public space, this is the only area to have existing, underutilized green space where landscaping can enhance the visual experience for all roadway users.

The Isles is a complex section of the Las Olas Corridor in and of itself. Emergency response times are some of the worst in the city, flooding is a regular occurrence, and it is the only section of the corridor experiencing a speeding problem. An emergency management substation is needed. It is anticipated that a next phase of study along the corridor will be to provide engineering recommendations on how to combat persistent flooding. Speeding can be mitigated through techniques suggested in this report, which will have no impact on the ability to evacuate during an emergency.

This is the longest segment of Las Olas Boulevard, and has two distinct character areas, both are residential but with differences in accessibility and land use. Our recommendations acknowledge that east of Seven Isles Drive, there are retail, small office, and restaurant uses that currently exist on the south side of Las Olas Boulevard.

Curbside bike lanes exist here, but it can be stressful to ride along side traffic on a facility where the posted speed is 35 mph and an observed speed is about 40mph. This is

the only section of the corridor experiencing speeding. The overall goal in the Isles section of the Corridor is to allow for an efficient flow of traffic, but not speeding, which creates a host of safety issues. Speeds need to be lowered on this portion of the corridor, not only to make it safer for cyclists who ride along the corridor, but to accommodate safe, signal free, pedestrian crossings of the corridor. Studies have shown that traffic speeds can be lowered by a number of traffic calming techniques. These include, reducing travel lane width, lane removal, pavement marking and striping, signal coordination, speed feedback signs, strict enforcement, and multi-lane roundabouts at intersections replacing signals. The most effective techniques are the most intrusive. The City is in control of the posted speed limit and can do the analysis necessary to lower it. The lack of north-south crosswalks, including at bus stops, is a subject of concern among community residents.

## Recommendations

It is recommended that the Isles section be redesigned with separated paths, plentiful shade and up to four crosswalks connecting the north and south sides of the street. The City is currently working on the immediate funding and implementation of at least one crosswalk.

Safety improvements can be implemented through the use of traffic calming to reduce documented speeding in the area, including increased visibility at the aforementioned crossings and elimination of sight distance issues related to the bridges on the north side of Las Olas Boulevard, as well as narrowing of vehicular lanes.

The Isles provides the most opportunity to create green spaces that will provide areas of rest for pedestrians. The

**Circle Locations are Proposed Mid-block Crossings**



landscape found in The Isles fully embraces the tropical theme and expands upon the existing conditions. The chosen species are all native and salt tolerant. Palms are the major feature in The Isles, but the palette has been expanded to include multiple new species. Trees will provide much needed shade, but will not detract from the tropical theme. The Isles also places a larger emphasis on shrubs and groundcovers than the other segments, utilizing dune species and tropical accents.

Generally, within this section of the corridor:

**1. Vehicular Travel Lanes:**

- a. Two lanes will remain in each direction. The outside lane will be at 11'; the inside lane will be at 10'. The recommendation of a 10' travel lane is in alignment with national engineering standards and poses no safety concerns. Lane width reductions are nationally

recommended ways of lowering traffic speeds, and are appropriate.

- b. Median: Retained at 12 feet, with existing landscaping.
- c. Visibility issues at each north-south bridge on the north side of Las Olas Boulevard shall be addressed by providing for sight triangle extensions that will include reconstruction of bridge railings/walls. To do this an analysis of the sight triangles should be performed to determine the extent they do not comply with City standards for a corridor of this classification. In its basic form, the sight impediments such as railings would be reconstructed to accommodate an appropriate sight triangle. Due to the nature of these structures, coordination will need to occur not only between the City and FDOT, but with the State Division of Historic Resources. A full methodology will be able to be articulated at that time.

## 2. Bicycle:

- a. West of Seven Isles Drive: Bicycles lanes at 7' with a 2' curb separating bicycles from vehicular traffic.
- b. East of Seven Isles Drive: Bicycle lanes at 4'.
- c. With the goal of eliminating the need for pedestrian signals at the cross walks, the City should seek to lower the posted speed limit to 30 mph in order to make it safer for cyclists and pedestrians.

## 3. Sidewalks:

- a. At least 7' wide on both north and south sides of Las Olas Boulevard.
- b. Up to four pedestrian crossings are proposed. These would be located at S. Gordon Road, Hendricks Isles, Isle of Venice Drive, and Coral Way. Due to the posted and observed speed of the road, pedestrian actuated crossing signals may be required to assure pedestrian safety, as per national engineering standards.

## 4. Wayfinding and Landscaping:

- a. To improve the pedestrian experience, shade trees should be intermixed with the palms at regular intervals. This will create more shade for users and limit the "heat island" effect in the area.
- b. The Isles already has an iconic look due to its allée of Royal Palms within the medians. The proposed landscape should maintain this identity while simultaneously improving the pedestrian experience.
- c. A landscaped buffer of shade trees, shrubs and ground cover is proposed between the sidewalk and the bicycle path west of Seven Isles Drive. This buffer should be 8' wide, but may be less wide in areas where right-of-way is constrained.

- d. No infill into the water is proposed.
- e. Hardscape area as noted in the wayfinding and other sections of this plan features the words "Meet Me @ Las Olas" and acts as the starting point of the flowing hardscape design/pattern seen throughout the entirety of Las Olas Boulevard.
- f. Benches can be added to bus stops along the north and south sides of the corridor in The Isles, as can bike racks.
- g. The following provides details for proposed green spaces and rest areas:

### West Isles Green Space

After crossing the bridge from Colee Hammock into The Isles, the users find themselves in the West Isles Green Space. This passive, open area acts as a landing zone after crossing the bridge and an area of rest before the almost mile trek to the beach. The West Isles Green Space provides a safe, shaded, walkway away from the road. It allows the user to interact with the water as the path runs along the canal. The open lawn allows for users to rest and take in the beauty of The Isles.

The proposed landscape consists of an open lawn with shrub buffers separating it from the road. The chosen shrubs should be of a species that can be maintained as a hedgerow to provide a buffer, while maintaining vehicular line of sight for security. The pathway within the green space should split and weave around a specimen Gumbo Limbo flanked by accent trees. The pathway to the west should allow for connection to the proposed bridge expansion. As the pathway continues to the east, it should be flanked by the existing seawall and flowering accent

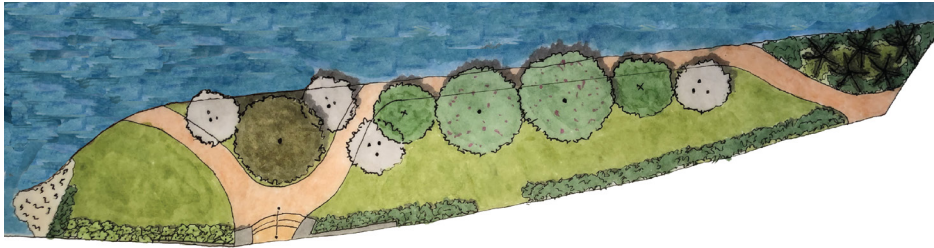

trees of various sizes, capped off with a cluster of Alexander Palms at the intersection of Las Olas Boulevard and S. Gordon Road. The pathway between the wall and accent trees is proposed to include path lighting. The area below the specimen Gumbo should remain as open lawn, while the spine of accent trees along the path should use shrubs to create a buffer between the path and open lawn space. Site amenities within the West Isles Green Space should be limited to trash receptacles and a bike rack. The West Isles Greenspace is contemplated as a passive area. No benches are planned in this space.

### Isles Rest Nodes

The Isles District should have multiple rest nodes located in the blocks between the finger islands. There are two designs for these rest nodes, one large and one small, both of which utilize space within the right-of-way and not extend into the waterway.

Rest nodes are contemplated on both the north and south sides of the corridor. On the north, up to four nodes in total are planned. Tentatively large nodes are planned between Nurmi Drive and Royal Palm Drive, and between S. Gordon Drive and Hendricks Isle Drive. A small node is planned between Isle of Venice Drive and NE 20th Avenue.

On the south side large nodes are planned between Lido Drive and San Marco Drive, and between San Marco Drive and Coral Way. It should be noted, that there are right of way constraints and flooding on the south side of the street, which may impact the exact design.

### Isles Rest Node (Large)

The large Isles Rest Node should create an open area in which users can rest and engage with the views of the waterways. The large Isles Rest Node should contain two, canvas shade structures over bench seating so that users can briefly relax in between Colee Hammock and the beach. The “Meet Me @ The Isles” hardscape feature should provide continuity from this location to the other Districts. The center of this feature should be large enough to house a public art installation, and should the City choose not to use this for an art installation, it should be transformed into a cluster planting of palms surrounded by Railroad Vine. The rest node should be surrounded by shrub beds that are high enough to create a visual buffer between users



and the residences opposite them on the canal. The beds should follow the curvature of the hardscape to frame the view so that users are not looking directly into private property. While this is to be a passive space it should not be used for activities other than rest. The shrub beds and shade trees within them should act as a sight and sound buffer for the nearby residences. The area is proposed to be lit with bollard lighting that has a downward throw to avoid light pollution.

The shade trees next to the Large Isles Rest Node are to be either Clusia (Pitchapple) or Pigeon Plum to maintain the tropical feel of the location. Small accent palms can run parallel to and along the sidewalk to enhance the transition into the rest node.

### Isles Rest Node (Small)

The second rest node typology is conceived as a more intimate experience. Like the Large Isles Rest Node, this space is programmed to be a passive area of rest. The



Small Rest Node should not contain any benches or shade structures. A single small-to-medium sized tree, per the plant palette, should be contained within a raised planter. Should the user like to sit and rest, the circular planter can be used as an impromptu bench. Much like the Large Rest Node, this node should be flanked by layered shrub beds that create a visual buffer between the space and residences across the canal. The beds should follow the curvature of the hardscape to funnel the view towards the center of the canal. Small accent trees and palms should be planted among the shrubs to add to the texture and tropical feel of the space. Low level illuminated bollards and an integral LED strip light on the underside of the raised planter are expected. Required site amenities include trash receptacles, and a bike rack, however no benches are located within the site.

### East Isles Green Space Idlewyld Park to Merle Fogg Park Connection

Merle Fogg Park and Idlewyld Park sit on the eastern boundary of The Isles and flank the Intracoastal Bridge on the south and north side of Las Olas Boulevard, respectively. While Merle Fogg Park has some programming, Idlewyld Park sits as an open area with access to some storage underneath the Intracoastal Bridge. The project is to transform Idlewyld Park into a programmed green space that directly connects to Merle Fogg Park.

It is necessary to implement a pump station in Merle Fogg Park. City departments including Parks and Recreation, Public Works, and Transportation and Mobility, are coordinating the location of this critical piece of infrastructure to determine if it should be on the north or south side. The goal for this park is to make it more inviting

with a pathway to the water and a promenade along the shore.

The East Isles Green Space is intended for lower scale landscaping to preserve its views. Shrubs and understory trees should diffuse the bridge support walls and provide an entryway into the space. A pathway is proposed to lead from Las Olas Boulevard to the Intracoastal where it would meet a proposed boardwalk. This boardwalk would go underneath the bridge abutment and provide a direct pedestrian connection to Merle Fogg Park. The boardwalk would provide a safe connection that does not cross vehicular traffic. Additional benches should be located near the water's edge to provide a rest area before or after crossing the bridge. Low-level illuminated bollards are proposed to be placed along the path, with lighting along the boardwalk that meets the standards for sea turtle lighting. The East Isles Green Space enhancements are to repurpose a previously empty lot into an area that benefits the community.

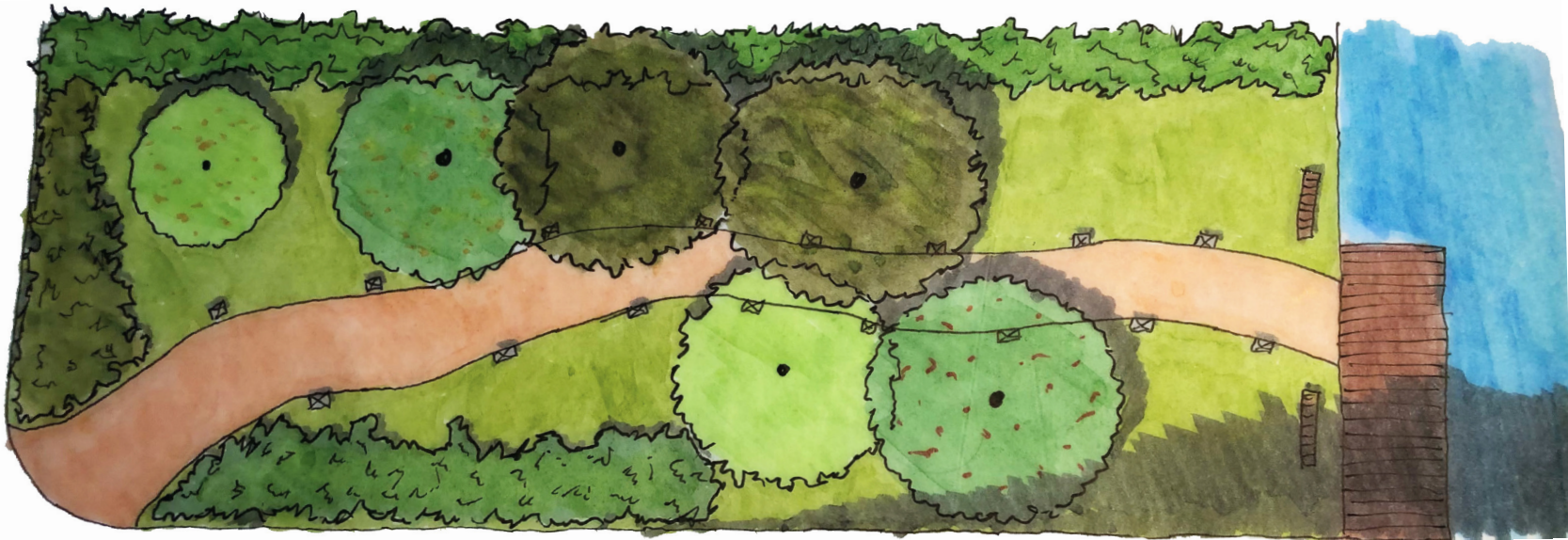

THE ISLES

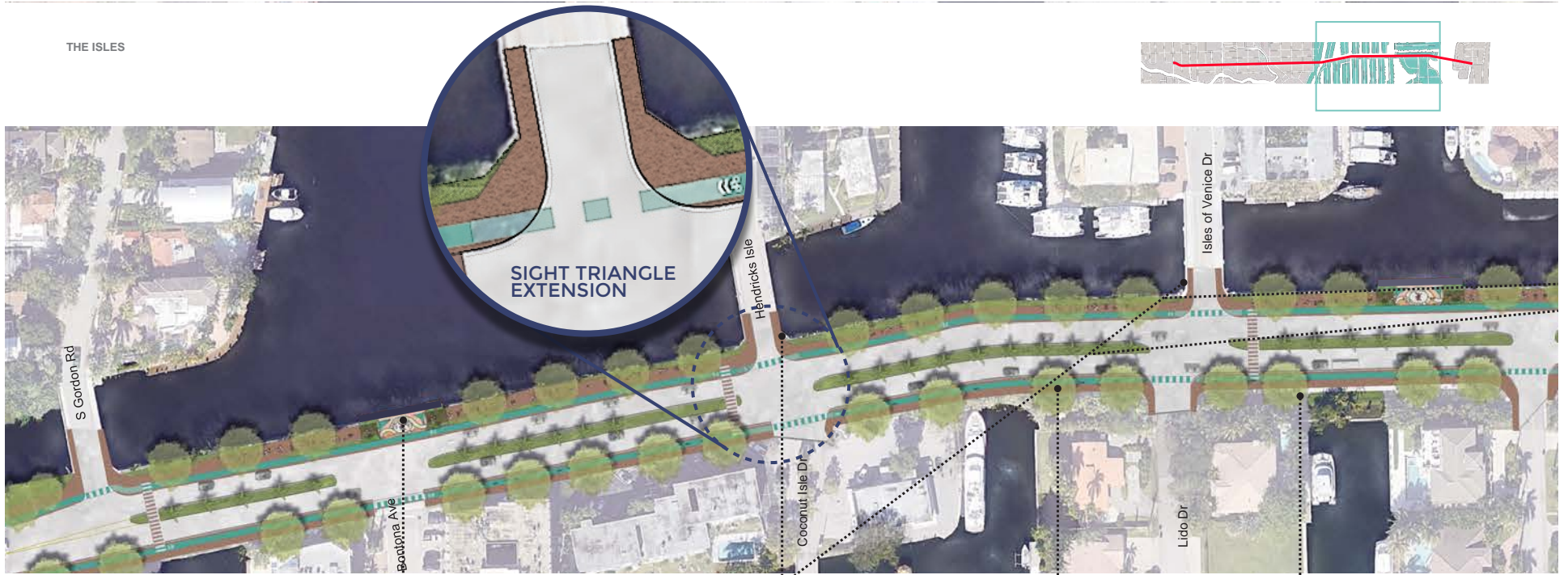

**New Crosswalks**  
Multiple locations



**Landscaped Areas**



**Sight Triangle Extensions**  
Improved visibility at each bridge along the North side of Las Olas



**Shade Trees**



**Bus Stop Improvements**  
Improved crossings

THE ISLES

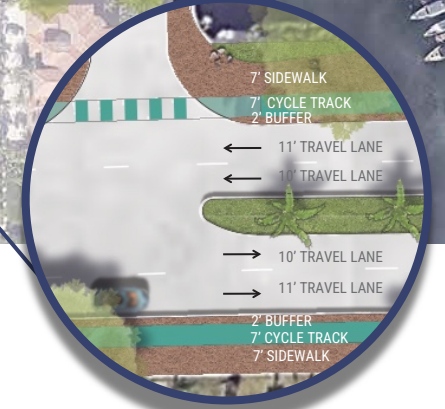

DIMENSIONS



One-Way Cycle Tracks



Historical Markers



Improved Lighting and Crossings



Concept for One-Way Cycle Tracks



Resiliency - Silva Cells for Stormwater Management



THE ISLES

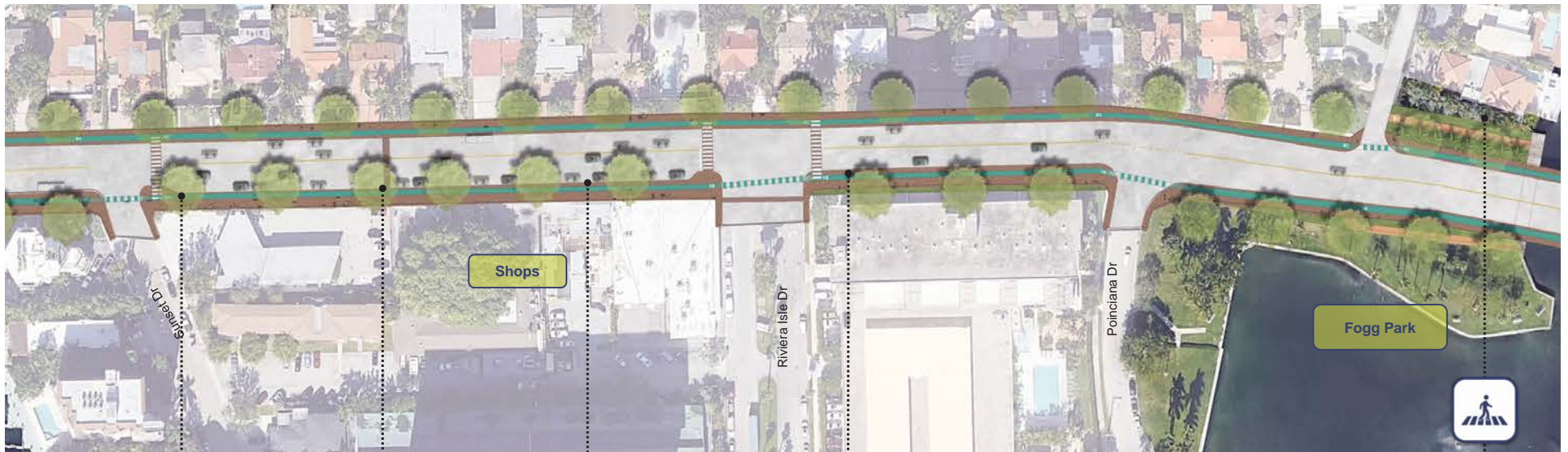

Shade Trees



Enhanced Crosswalk



Parallel Parking



One-way Cycle Tracks



Concept for East Isles Underpass

**LEGEND**

- NO CHANGE
- MINOR CHANGE
  1. Enhanced Pedestrian Crossings and Sight Distance Improvements

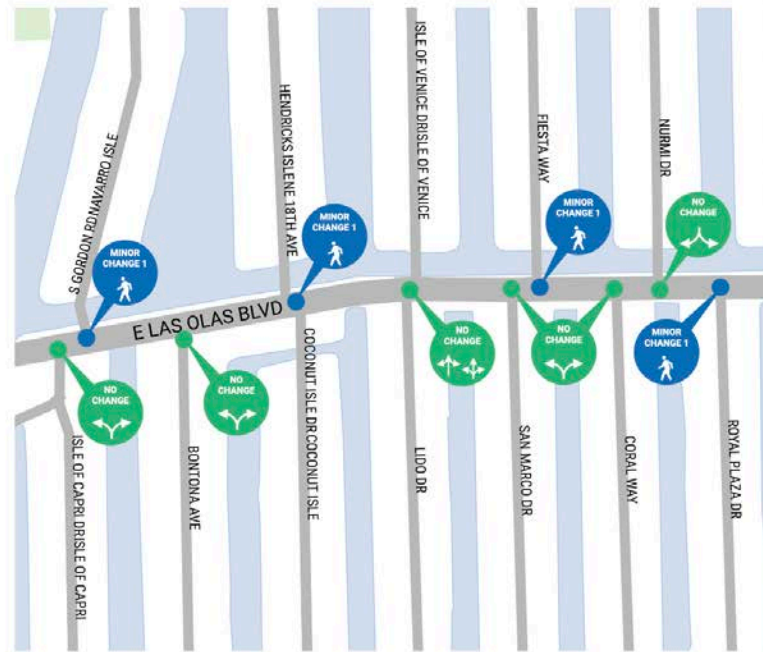

The Isles Segment A Traffic Summary

**LEGEND**

- NO CHANGE
- MINOR CHANGE
  1. Enhanced Pedestrian Crossing
  2. Bicycle Traffic Light
  3. Bridge Underpass



The Isles Segment B Traffic Summary

### The Isles Existing Section between Sospiro Canal and SE 23rd Avenue

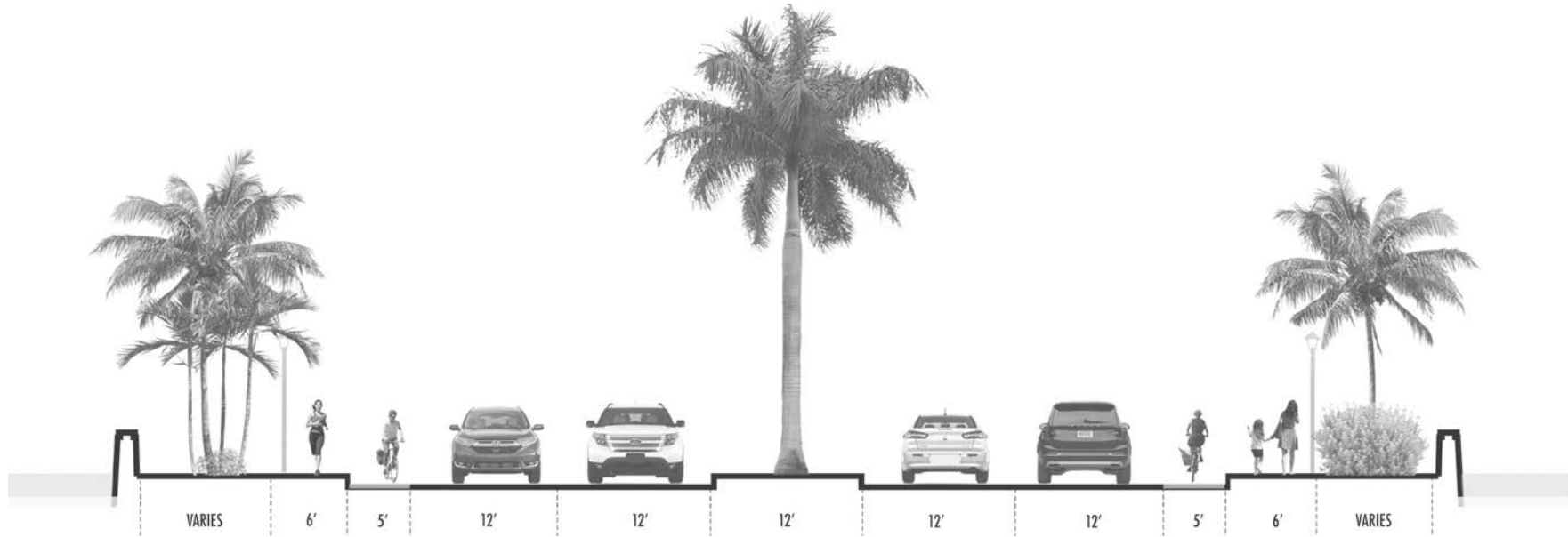

### The Isles Proposed Section between Sospiro Canal and SE 23rd Avenue

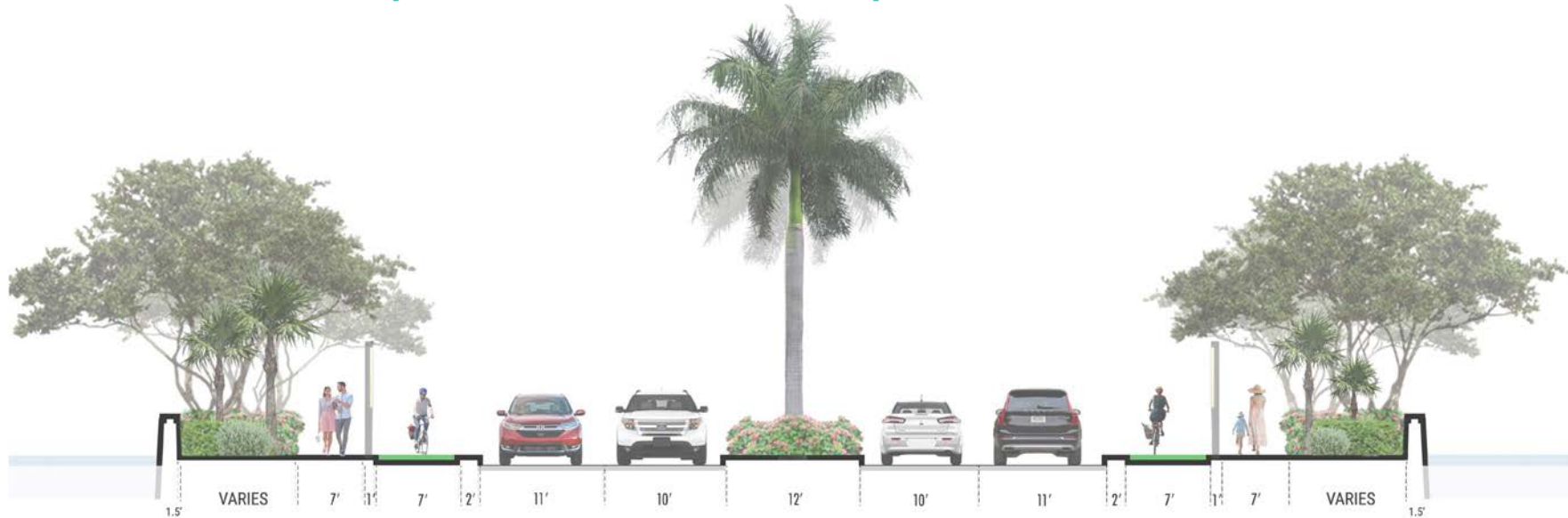

The Isles Existing Section between SE 23rd Avenue and Plaza Las Olas

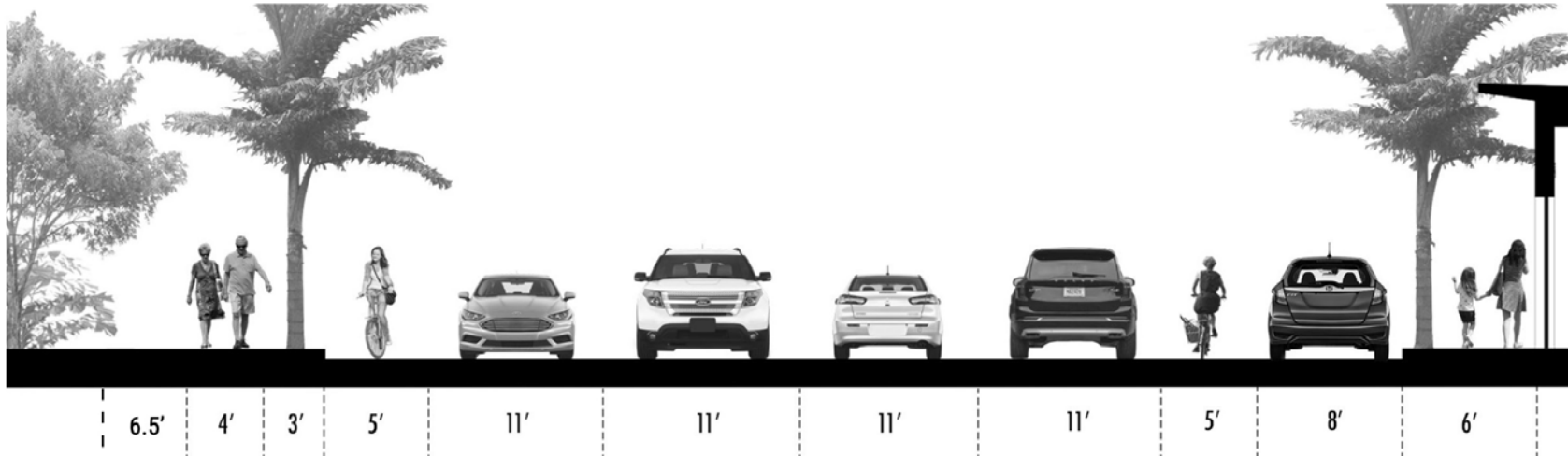

The Isles Proposed Section between SE 23rd Avenue and Plaza Las Olas

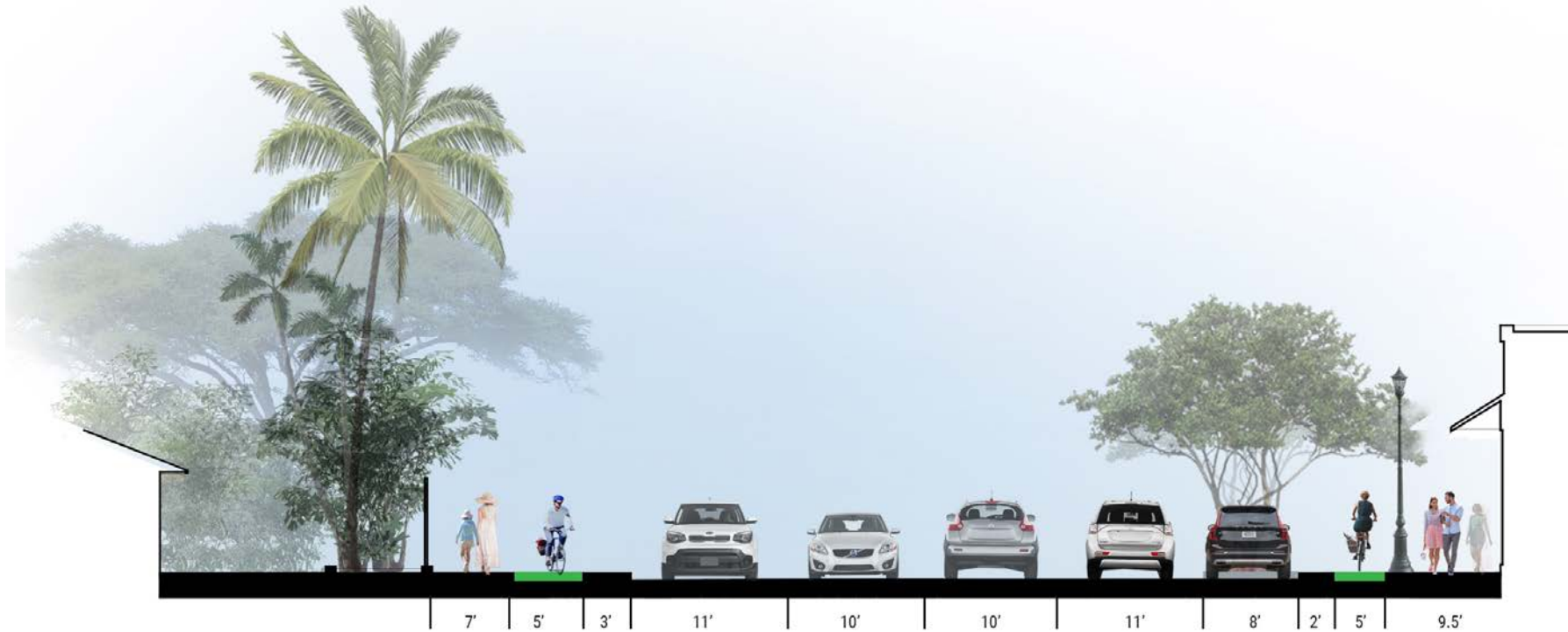

The following provides for the recommended plant palette for The Isles area.

### Large Trees



*Quercus Virginiana*  
**Live Oak\***



*Bursera simaruba*  
**Gumbo Limbo\***



*Coccoloba diversifolia*  
**Pigeon Plum\***

### Medium Trees



*Eugenia foetida*  
**Spanish Stopper\***



*Clusia rosea*  
**Pitchapple\***



*Rhizophora spp*  
**Mangrove\***

### Small Trees



*Conocarpus erectus var. sericeus*  
**Silver Buttonwood\***

### Large Palms



*Sabal palmetto*  
**Cabbage Palm\***



*Archontophoenix alexandrae*  
**Alexander Palm**



*Bismarcia nobilis*  
**Bismark Palm\***

### Medium Palms



*Psuedophoenix sargentii*  
**Buccaneer Palm\***



*Coccothrinax argentata*  
**Silver Palm**

Small Palms



*Thrinax radiata*  
**Florida Thatch Palm\***



*Latania loddigessii*  
**Blue Latan Palm**

Shrubs



*Conocarpus erectus*  
**Green Buttonwood\***



*Clusia nana*  
**Dwarf Clusia**



*Crinum spp.*  
**Crinum Lily**

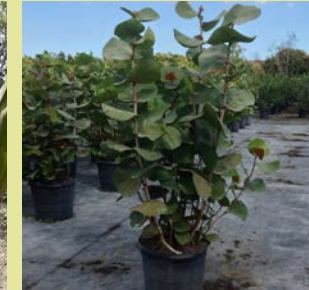

*Coccoloba uvifera*  
**Seagrape**



*Chrysobalanus icaco*  
**Cocoplum "red tip"\***



*Ficus microcarpa*  
**Green Island Ficus**



*Ipomoea pes-caprae*  
**Railroad vine\***



*Seroena Repens*  
**Saw Palmetto\***



*Bougainvillea spp.*  
**Bougainvillea**



*Hamelia patens var. glabra*  
**Dwarf Firebush\***

## Vines

Vines are very beneficial to a project's planting palette. They soften hardscapes, reduce heat, attract pollinators, and form stunning living screens, especially while flowering. The various species will be utilized in the shade structures throughout the corridor. Vines can be separated into four basic types based on their climbing habits: Clinging, Twining, Sprawling, and Tendril Climbing.



SPECIES	NATIVE	IRRIGATION NEEDS	LIGHT REQUIREMENTS	CLIMBING HABIT	FLOWER COLOR	FLOWERING SEASON
<i>Passiflora incarnata</i> - Passion Flower	Yes	Low	Full Sun	Tendril Climbing	White & Purple	Spring - Summer
<i>Gelsemium sempervirens</i> - Yellow jessamine	Yes	Moderate	Full Sun - Part Shade	Twining	Yellow	Winter-Spring
<i>Campsis radicans</i> - Trumpet creeper	Yes	Low	Full sun -Shade	Clinging Roots	Orange - Red	Spring - Summer
<i>Bougainvillea spp.</i> - Bougainvillea	No	Low	Full Sun	Twining	Red, Pink, Orange	All Year
<i>Allamanda cathartica</i> - Golden Trumpet	No	Moderate	Full Sun	Sprawling	Yellow	Warm Months
<i>Trachelospermum jasminoides</i> - Star Jasmine	No	Moderate	Full sun -Shade	Twining	White	Spring
<i>Bignonia capreolata</i> - Crossvine	Yes	Low	Full Sun - Part Shade	Tendril Climbing	Orange - Red	Spring
<i>Lonicera sempervirens</i> - Coral Honeysuckle	Yes	Low	Full Sun - Part Shade	Twining	Orange - Red	Spring- Fall



*Passiflora incarnata*  
**Passion Flower\***

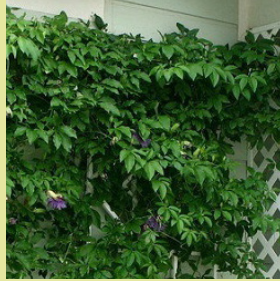

*Bougainvillea spp.*  
**Bougainvillea**



*Bignonia capreolata*  
**Crossvine\***



*Gelsemium sempervirens*  
**Yellow Jessamine\***



*Allamanda cathartica*  
**Golden Trumpet**



*Lonicera sempervirens*  
**Coral Honeysuckle\***

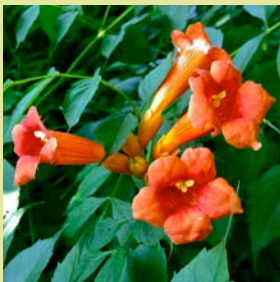

*Campsis radicans*  
**Trumpet Creeper\***

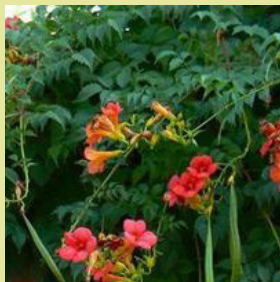

*Trachelospermum jasminoides*  
**Star Jasmine**





## » The Beach



The Beach section of Las Olas Boulevard is the smallest section but anchors the corridor as the destination on the eastern end. The City has recently undertaken efforts to improve the area with Oceanside Park and reconstruction of Las Olas Boulevard. To connect thematically to the rest of the corridor, new wayfinding, as well as considerations of landscape continuity, will afford the City an opportunity to build upon existing efforts.

While technically outside of the study area, to provide for unity of the corridor as a whole, landscape and bicycle pathways should be coordinated with the other segments, and recommendations for plant palettes are provided as part of this study. In addition, a coordinated multi-use path is proposed to cross the Intracoastal Waterway to allow bicyclists to reach these destinations as well as connect with the Route A1A bike lanes.

Further work needs to be done subsequent to this effort which further engages stakeholders on the beach to examine traffic patterns, bicycle and pedestrian mobility, and the placement of traffic operations controls such as a median east of the bridge to supplement the Corridor improvements and coordinate with the parking garage and marina.

## Recommendations

### 1. Vehicular Travel Lanes:

- a. Existing design plans for travel lanes should be implemented
- b. Birch Road/Las Olas Boulevard/Las Olas Circle: Additional study is needed to determine whether the median should be replaced due to access and conflict concerns.

### 2. Pedestrian and Bicycles:

- a. Cantilevered pedestrian/bicycle pathway: This study recommends a bicycle pathway be added to the Intracoastal Waterway bridge. This will be a one-directional path on both sides of the bridge. Careful attention must be paid to whether the bicycle structure can be safely added to an existing bridge. Cantilevering a facility on the sides of a highway bridge, may for example introduce loading conditions for which the structure is unsuited.
- b. At least 6' wide sidewalks should continue to be maintained.

### 3. Wayfinding and Landscaping:

- a. Hardscape area as noted in the wayfinding and other sections of this plan features the words "Meet Me @ Las Olas" and acts as the starting point of the flowing hardscape design/pattern seen throughout the entirety of Las Olas Boulevard.



THE BEACH



**Bridge Improvements**  
Cantilever expansion of  
multi-use path



**Bridge Multi-Use Paths**

THE BEACH



**Multi-Use Path**



**Median Extension**

Additional study is needed to determine whether the median should be replaced due to access and conflict concerns.



**Gateway**



**Shade Trees**

**LEGEND**

-  **NO CHANGE**
-  **MINOR CHANGE**
  - 1. Bridge Underpass
  - 2. Additional Access
  - Study Is Needed Regarding Median

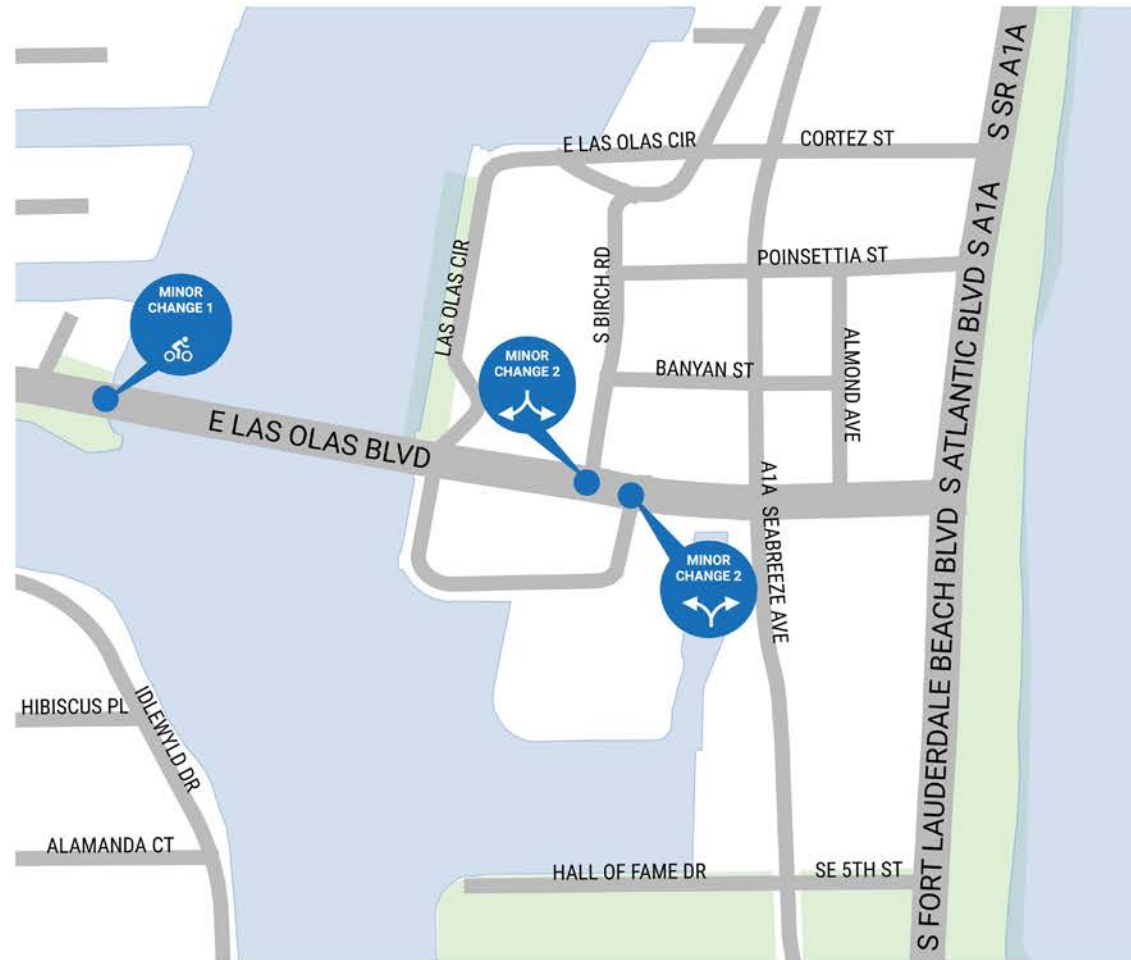

## The Beach Traffic Summary



# » IMPLEMENTATION SEQUENCE AND COST ESTIMATES

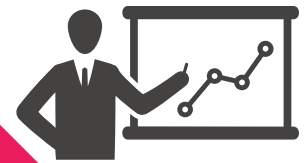

## » IMPLEMENTATION SEQUENCE AND COST ESTIMATES

Implementation of this vision for Las Olas Boulevard requires detailed attention given both the magnitude of the project, and its effect on day-to-day life during construction. This section reflects the overall Las Olas Boulevard creative branding, and is applicable to both Eastern and Western Corridor reports, covering all five character areas.

Drainage improvements are needed in The Isles section and may be needed in some portions of Las Olas Boulevard within Colee Hammock. These improvements will require invasive roadway techniques, so it will not be cost-effective to make streetscape improvements only to have them disrupted by underground repairs and enhancements. These improvements are not currently scheduled in the City's Capital Improvements Plan, which places construction after 2026; therefore, the Isles section improvements should occur later than those in other sections of Las Olas Boulevard.

The City should consider that various types of funding may be available for individual aspects of the project. For example, midblock crosswalks and other bicycling and pedestrian improvements qualify under Transportation Alternatives, while funding for aspects of water and drainage improvements can be available from several sources, including the Florida Department of Economic Opportunity. As funding becomes available, the City should reprioritize aspects or entire sections to take advantage of funding availability.

Considering the above, the following provides the recommended segment prioritization for implementation:

1. Colee Hammock
2. The Beach (excluding Cantilever Bridge)
3. The Isles

### Landscaping Implementation Criteria

For any streetscape design project, details of landscape implementation are extremely important and must go beyond a simple redesign of the multimodal facilities within the right-of-way to enhance mobility aspects. The range of landscaping elements from shade to seating and wayfinding have a significant impact on an individual's experience.

To successfully emphasize the iconic nature of Las Olas Boulevard, implementation must establish, at the forefront of the design, each area's theming, consistent with the overall goals of the project. The visual aesthetic of the landscape, hardscape, wayfinding, and sight amenities must cohesively work to enhance the user experiences. The user experiences, both from pedestrian and vehicular standpoints, are vitally important to the success of this project. During the conceptual masterplan process, alternatives were explored, and recommendations have been outlined that may not completely comply with the City of Fort Lauderdale Design Standards set forth by the City's Zoning Ordinance and Code regulations. Recommendations for implementation, formed through the master planning process, are outlined below along with the relative design standards and code regulations from the City of Fort Lauderdale.





## Landscape Recommendations

- » A tree inventory of the existing site was completed in March 2020. It is recommended that this inventory be confirmed before final design and implementation.
  - ◆ Based upon the current tree inventory:
    - Trees and palms with poor or dead ratings should be removed from the site.
    - Trees and palms with a “fair” rating should be relocated on site, when possible. The designer is to

coordinate with both the City Urban Forester and Parks and Recreation Department to relocate trees and palms to other City-owned property if on-site space is not available.

- Royal Palms in The Isles medians are not to be removed unless dead or in poor condition. Any royal palms removed from the median must be replaced with the same size and species. Other royal palms outside of The Isles medians, in any area, should be removed and replaced with a selected species from

the proposed plant palette, per City Urban Forester recommendation.

- Trees that will remain on-site during construction should be securely protected by a protection barrier.

» The proposed plant palette has been endorsed by the City of Fort Lauderdale Urban Forester. Each section's specific plant palette can be found in its respective portion of this report.

- ♦ While the specifications are written as minimum sizes, the installation of larger plant material is encouraged when available.
- ♦ Silver Buttonwood, Spanish Stoppers, and Simpson's Stoppers are to be specified as multi-trunk.
- ♦ All shrubs must be of the dwarf variety when species selection allows.
- ♦ Crape and Queen Crape Myrtles are recommended in the Colee Hammock and Isles Areas. These must be properly located within the site to acclimate to/ tolerate a salt environment.

» All trees must be surrounded by pervious surfaces to allow for irrigation and stormwater infiltration. Tree grates are not approved and must not be used within the project, per the City of Fort Lauderdale Urban Forester.

» All trees within hardscaped areas must utilize a tree root cell system, i.e., the City of Fort Lauderdale preferred Silva Cell System by Deeproot.

- ♦ Silva Cells allow for proper root growth, stormwater and irrigation infiltration, and pavement support. The use of Silva Cells will reduce the opportunity for future damage to both the trees and hardscape.

- ♦ Soil volume and root space within Silva Cells varies based on mature canopy spread and DBH (Diameter at Breast Height). Reference is to be made to the "How Much Soil to Grow A Big Tree" pamphlet and Deeproot contacted for recommended ratio of tree size-to-soil volume.

- ♦ To decrease the amount of Silva Cells needed, it is recommended that large and medium trees, as noted in the plant palette, utilize the 32" deep cells, while small trees should use 17" deep cells.

» Tree Placement:

- ♦ Trees should be placed no more than 40' on centers throughout the corridor, while accounting for regulated sight lines and distances.

• Low-low/high-efficiency irrigation is to be used whenever irrigation is necessary. As of the writing of this document, the City of Fort Lauderdale uses Rainbird brand irrigation equipment.

- ♦ It is recommended that this preference be reconfirmed prior to final design and installation.

» Soil amendment:

- ♦ It is recommended that the soils in each area be sampled and tested prior to final design and installation. Soil amendment may be necessary, depending on test results.

» Should the ROW within The Isles be raised to combat flooding, sea level rise etc. (not covered within this project scope), the existing Royal Palms within the medians must be raised to meet the new standard. This most likely will be done through relocation/removal and replacement.

## Signage and Wayfinding (Corridor-wide Considerations)

Wayfinding is key to creating the identity and branding of the Las Olas Corridor. As the corridor currently sits, there is no thematic or visual connector of the four districts to themselves, or the beach. These elements work to unify the four different districts and the beach through consistent theming and symbology. Some pieces are subtle while others are meant to grab attention and reinforce the “Instagram-able” moment. Integration of technology into the signage and wayfinding is vitally important for the project. A hierarchy of design allows for accessibility to both pedestrian and vehicular users. Symbology should maintain a consistent hierarchy, and adhere to the branding found in the wayfinding exhibits.

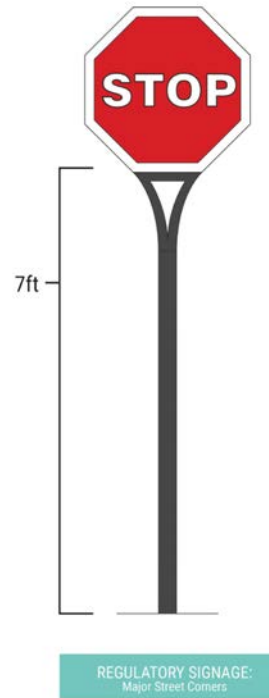

The hierarchy of wayfinding is based on the information the signage provides and how often it can be found. Large signs that contain multiple forms of information are less common along the corridor and therefore command more attention. These major forms of wayfinding include the open space and street corner signage.

The common wayfinding signage provides subtle and symbolic notation of current location and other destinations. The symbols laid out in the wayfinding exhibit are found on bike racks and bollards throughout the corridor. Each district utilizes the same bike rack form, however, each depicts its own distinct symbology within the “Meet Me

@” swirl. Bollards are found at midblock crossings and intersection crosswalks and utilize the same symbology. The given district symbology and swirl are engraved within the top of the bollard, while generic locations, such as district names or “Parking” and directional arrows, are engraved on the east and west sides of them as well as on the street face. The trellis iconography and bike racks are meant for subtle hints of location and branding on the pedestrian level, while the bollards can be utilized by vehicular users as well.

The open space signage is found in specific identity nodes such as the West and East Isles Green Spaces. This signage is designed to be at a pedestrian scale, approximately 4.5’ tall and 4’ wide. Therefore, multiple symbols, directions, and locations (both along and outside of the corridor) are shown. The curvature of the sign’s legs and ellipse main board reinforce the “Meet Me @” hardscape features. These two design features are also found on the corner signage. The corner signage displays pertinent information for vehicular users, and due to its size can be more specific in nature. Corner signage is found at the major intersections of SE 15th Avenue with Las Olas Boulevard. Similar in design to the open space signage, the corner signage has curved legs and an ellipse main board, where the board is a minimum of 7’ above ground. The thin supports minimize any obstruction to pedestrian circulation, while the height and size of the signage allow for vehicular and pedestrian usage. To maintain consistency throughout the corridor, all regulatory signage, such as stop and speed limit signs etc., should be remounted on similar support sign panels as the corner signage.

DISTRICT ICONOGRAPHY

OTHER LOCATIONS

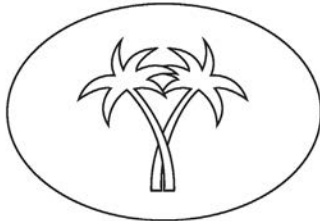
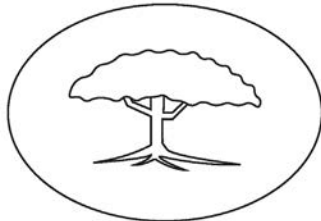

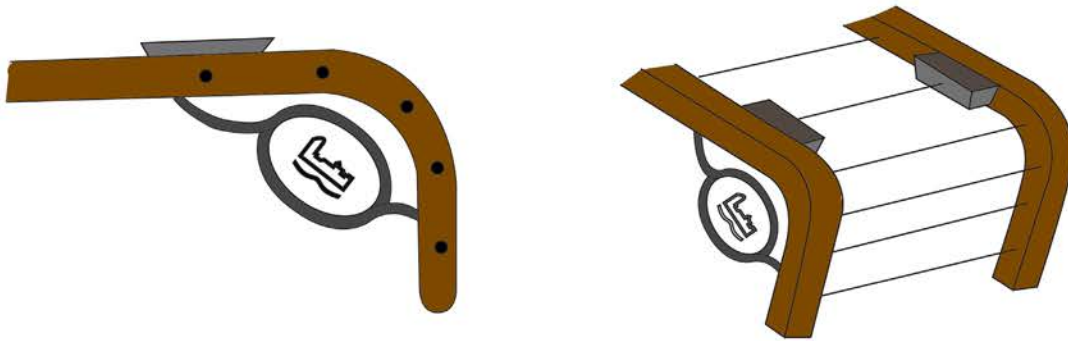

\*Vines not shown for clarity\*

TRELLIS ICONOGRAPHY:  
Colee Hammock Shops

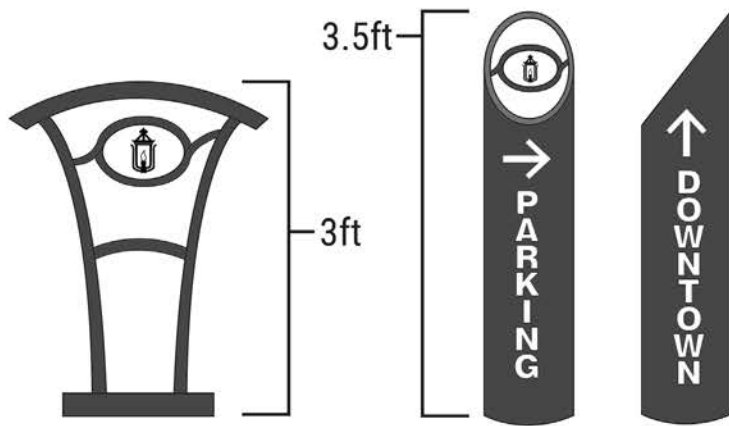

BIKE RACK:  
Throughout the Corridor

BOLLARDS:  
Mid-Block Crossings, Street  
Corners & Crosswalks

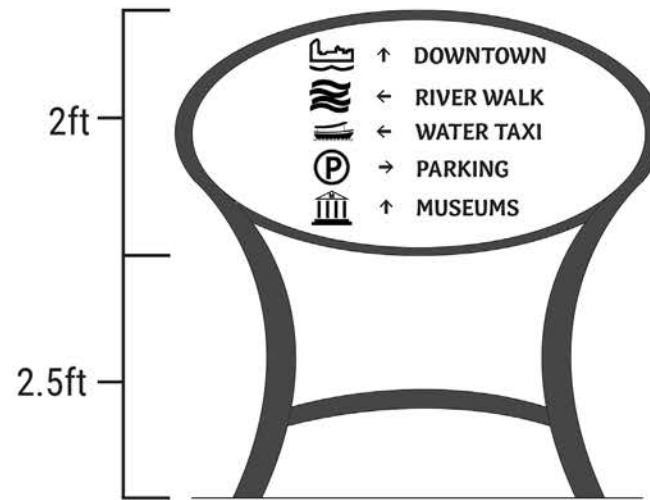

OPEN SPACE SIGNAGE:  
West Isles Park & East Isles Park

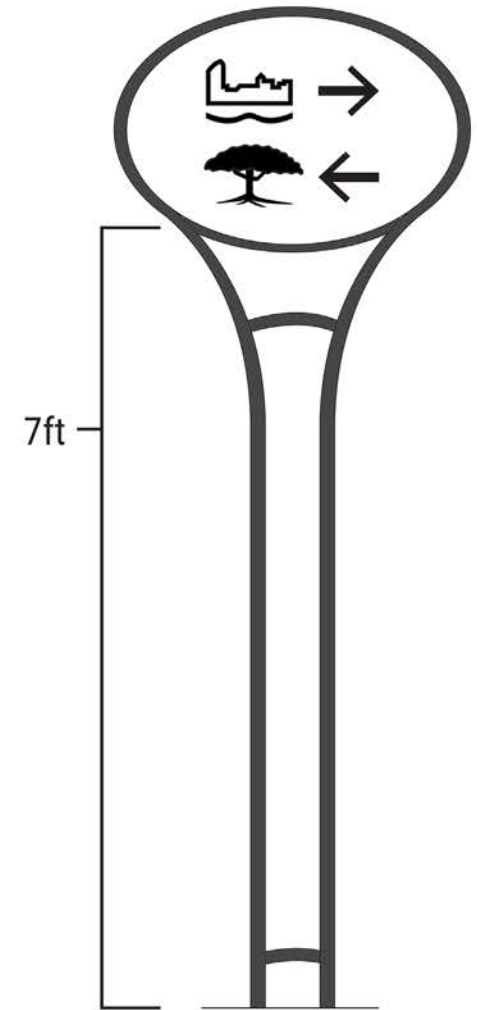

CORNER SIGNAGE:  
Major Street Corners

The outlier of the wayfinding hierarchy is the “Meet Me @” hardscape features in each district. The hardscape features become the iconic moment in each of the districts, and provide the “Instagrammable” moment while simultaneously giving the user a distinct location in regard to wayfinding. Each district has the slogan “Meet Me @” either “Colee Hammock”, or “The Isles” inlaid in the hardscape. The words fill out the swirl that can be found in all of the iconography previously outlaid. These areas present the opportunity for public art installations and impromptu seating, creating meeting spots and gathering areas. There will be two to three of these hardscape features; one in the Colee Hammock District (near SE 15th Avenue), and at least one in The Isles District within a large rest node.

These iconic areas will be prime for social media sharing and tagging and create a draw to each district. These nodes present the opportunity to introduce technology to the corridor. The “Meet Me @” locations can be geo-tagged in various apps and help people get around. Geo-tags can also allow for tagging in social media posts. This creates a distinct brand for the entire corridor that advertises itself through its users. Other forms of technology yet to be determined can be utilized in the previous forms of wayfinding. QR codes can be placed on bollards and signage that when scanned can reveal a list of surrounding businesses or current location, for example. It is recommended that the inclusion of technology through social media, apps, QR codes, and other options be addressed in final design.

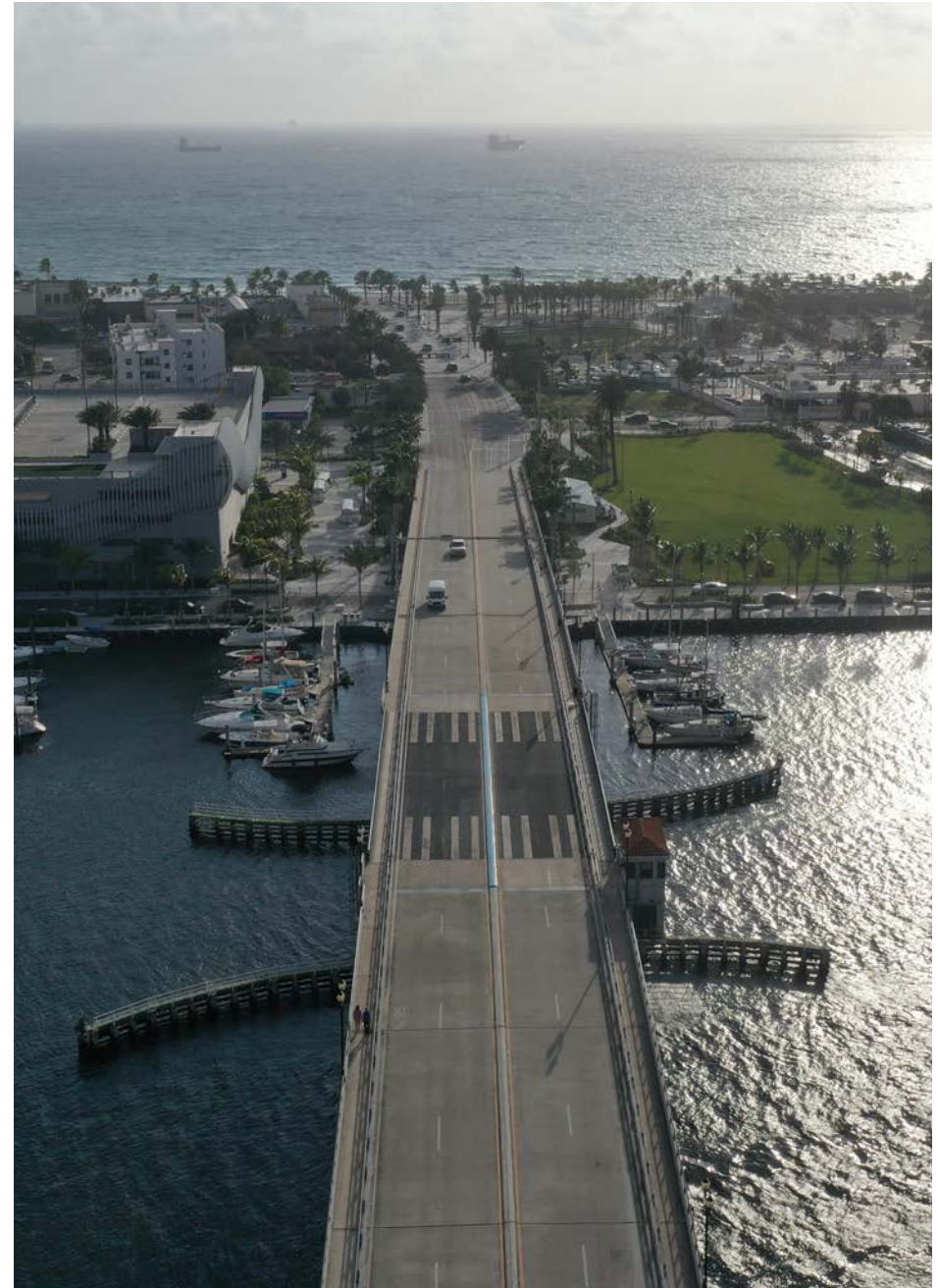

## Site Amenity Recommendations

The following images provide for examples of bicycle racks, light pole fixtures, trash receptacles, and benches for Las Olas Boulevard. These were selected to provide a modern look in line with the City's design for the Tunneltop Plaza as well as preferred designs utilized within the Downtown Development Authority area and those Citywide. However, through discussions with stakeholders, it was suggested and recommended that overall design selections for these amenities be deferred to civil engineering and design phase. Thus, these images are being provided as part of an "inspirational" approach, with the final selection in later project phases.

- » Trash receptacles are to be the City of Fort Lauderdale preferred model: *Victor Stanley DYN-SD-45* with dual-flow divider lid, in powder-coated black.
- » Bike racks are to be consistent with the conceptual design found in the wayfinding guidelines.
- » Benches are to be of a modern design with a mix of two types. The design should be made of wood, or composite material made to look like wood, and have sleek metal supports that can be direct buried.

## Hardscape Recommendations

- » Hardscape is to consist of integrally colored concrete, texturized with a surface retarder.
  - ♦ Integral color to be *Scofield* brand from Color Chart A-312, and include colors used in Las Olas Tunnel

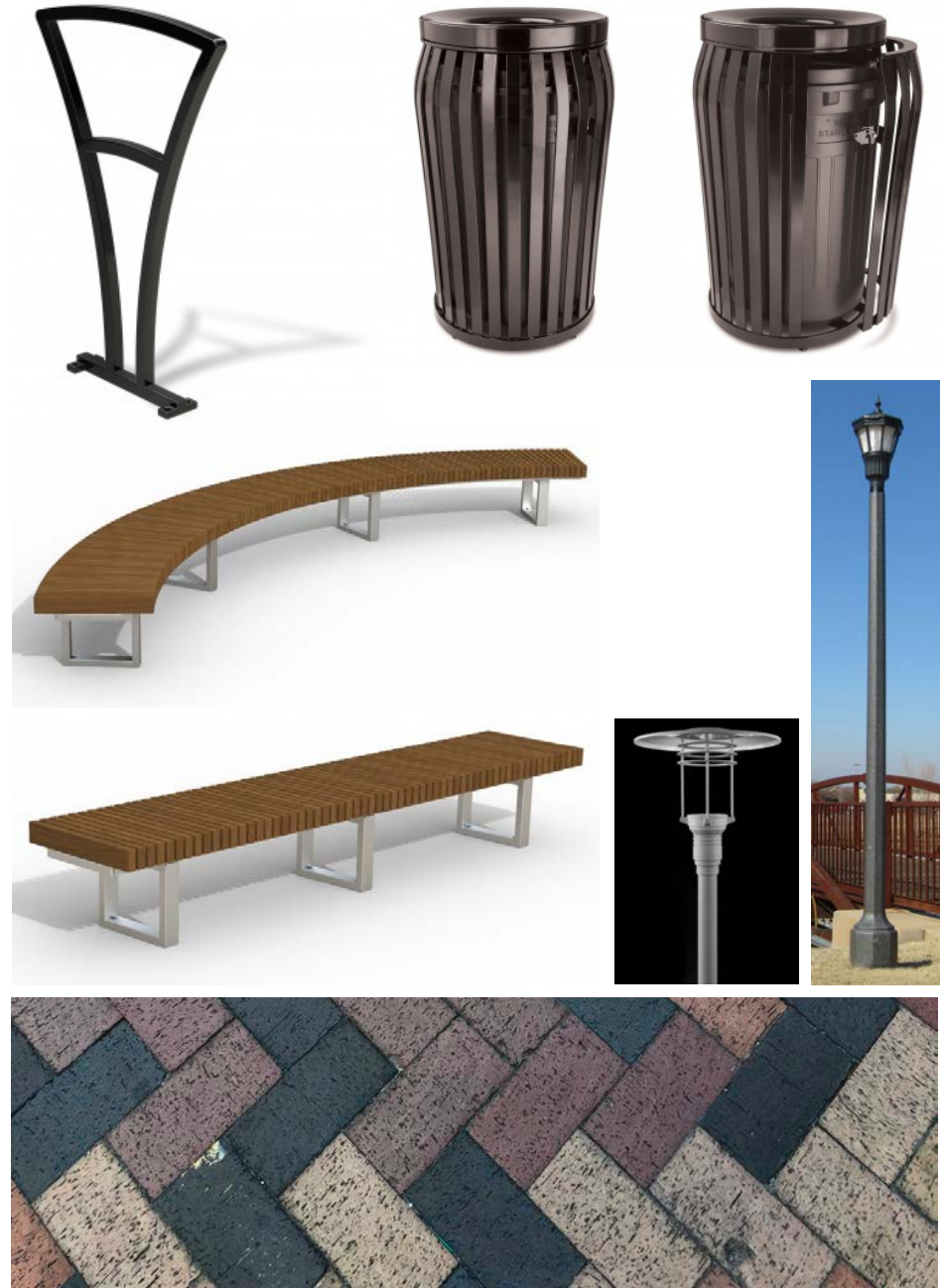

Top Plaza. Surface retarder to be *Scofield* brand *LITHOCAST Surface Retarder*.

- ◆ Curbs and dark gray bands referenced below to be color *C-34 Dark Gray*.
- ◆ Prior to design and installation, designer to reconfirm products and colors used within the Tunnel Top Plaza's installed hardscape.

#### » Primary pedestrian circulation

- ◆ Colee Hammock Area
  - Includes first 10' offset from the building façade.
  - A 6" *C-34 Dark Gray* concrete strip, offset from the building façade by 2', is to run parallel with the roadway to designate the threshold and area for trellis planter boxes. An 8" dark gray band to be offset from curb 2' for ADA compliance.
  - The darkest earth tone should fill the space between the façade and the gray strip, as well as in the space between that strip and the curb.
  - Concrete to be textured with surface retarder.
- ◆ The Isles Area
  - Sidewalk color is to match primary pedestrian circulation zone of The Shops and Colee Hammock areas.
  - Sidewalk is to be finished with surface retarder to texturize topcoat.
  - 8" *C-34 Dark Gray* strip to offset 2' from curb and between main circulation and Isles Rest Nodes.

#### » Expanded Pedestrian Zone

- ◆ Colee Hammock Area
  - The expanded pedestrian zones in Colee Hammock are to be a middle shade of earth tone, directly related to the coloration of the Tunnel Top Plaza.
  - This color is to be lighter than the primary pedestrian circulation, but darker than the roadway.
  - Concrete is to utilize a surface retarder to add a texturized topcoat. This texture will work as a tactile warning as users approach the roadway.
  - Dividing line between primary pedestrian circulation and this zone is to be dark gray and 8" Wide.

#### » Planters

- ◆ Shrub beds surrounding trees within the Colee Hammock Area are to be ringed with 6" wide dark gray colored concrete strip.

#### » Roadway

- ◆ Colee Hammock and The Isles Areas
  - Roadway not to be colored concrete; see roadway section for details.

#### » Identity Nodes

- ◆ The "Meet Me @" hardscape features are to use all three of the earth tones seen in previous hardscape design.
- ◆ "Letters" to have inlaid look, either sawcut and sunk stone, or marble or concrete.
  - Metal potentially used for "Letters" must be clear-coated cast aluminum or bronze.
- ◆ Colee Hammock Area
  - The center of the "Meet Me @" feature is to be white,



smooth trowel finished concrete.

- Swirl to be lightest earth tone with surface retarder finish, surrounded by 6" dark gray concrete strip, smooth trowel finish. Outer side of swirl is to match color and texture of primary pedestrian zone and expanded pedestrian zone.
- ◆ The Isles Area
  - Large Isles Rest Nodes
    - Center and swirl
- Area between swirl and sidewalk is to match primary pedestrian circulation color and texture of The Shops.
- Area between swirl and waterfront is to match expanded pedestrian zone color and texture of The Shops.
- West and East Isles Green Spaces/Small Isles Rest Nodes



## Relevant City of Fort Lauderdale Zoning Ordinances and Code Regulations

- » 50% of required street trees shall be shade trees.
- » Street trees shall be provided at a ratio of one street tree per forty (40) feet of street frontage, or greater fraction thereof.
  - ♦ Where overhead utilities exist, required street trees may be small at a ratio of one small trees per (20) feet of street frontage.
  - ♦ Where shade trees cannot be installed, palm trees or ornamental trees may be provided at a ratio of at least one palm or ornamental tree every twenty (20) linear feet of street frontage.
  - ♦ Approved trees for Las Olas Boulevard include Sabal Palm, Live Oak, Maypan Palm, and Carpentaria Palm. The proposed plant palette has been approved by the City of Fort Lauderdale Urban Forester to include other species within the RAC. However, a written appeal

request to the department may be necessary per **Sec. 47-21.14 Additional Landscape Requirements for Special Uses and Areas of the City Code.**

- ♦ The necessity for installation of an irrigation system for street trees (within the RAC) and the type and kind to be used shall be determined by the city based on tree species requirements.
- » Per City Code, trees must satisfy the following size requirements. (Refer to landscape OPC for tree sizing specifications).
  - ♦ Shade Trees: Minimum 14ft height and 8ft spread, with a minimum of 6ft ground clearance.
  - ♦ Palm Trees: Minimum 18ft height, with a minimum of 8ft green wood.
  - ♦ Ornamental Trees: Minimum 12ft height and 6ft spread, with a minimum of 6ft ground clearance.
  - ♦ Per designer recommendation, the installation of larger plant material is encouraged when available.
- » Trees to remain onsite during construction must be secured by a tree protection barrier meeting the City of Fort Lauderdale Standard Detail.



## Cost Estimates

Cost estimates have been developed at the “planning level” only, due to the need for additional considerations and discussions during the design phase, including considerations for the Colee Hammock area regarding both pending decisions on SE 16th Avenue and the intersection of 15th Avenue and Broward Boulevard, and the Isles section regarding the redesign of the north side bridges, as well

as the pending decisions for stormwater improvements. Estimates provided are based on comparable planning projects and adjusted based on the Florida Department of Transportation Long Range Cost Estimates and Historical Cost items. Contingency has been added to account for potential to mitigate drainage issues, or in the case of the Intracoastal Bridge.

Depending on the timeframe of implementation, inflation factors should be used. Final costs past the planning phase are contingent on the details of the engineering design of the corridor. During public discussion, the decision was made to select options that did not result in land acquisition (except for Sospiro Bridge, where the options for bridge widening include either minor acquisition of easements, or movement of existing water mains across the canal). However, should the City change its decision during the engineering design phase, land acquisition costs, if any, should be added. Other costs should be considered, depending on the drainage improvements to be determined by the City’s Public Works Department.

Florida Department of Transportation long range estimates (LRE), bridge cost and historical cost data from Group 12 (encompassing Broward County) were utilized as needed for roadway, bridge, and intersection improvements. In addition to the construction costs, PD&E (15%), Design (12%), CEI (15%), mobilization (10%) and Mobilization and Maintenance of Traffic (MOT) (10%) were all calculated based on the base construction cost and added to the list. In cases where the long-range estimates were utilized as the basis, MOT is already accounted for in those estimates and was not recalculated/adjusted.

Generally, the cost estimates were arrived at through a combination of cost estimates for individual landscape items, with tree specimens, benches, and wayfinding signs using prevailing costs. For landscaping, it should be noted that tree specimen costs utilized were sourced from prior projects or nurseries.

As a cross check, the cost of the improvements was compared to regional projects of a similar nature in the City of Miami, City of Coral Gables, and City of West Palm Beach. The per mile cost for as built ranges from \$4.88 million to \$5.68 million per 0.1 mile. When adjusted for inflation to give an “apples to apples” comparison, the upper end is in the range of approximately \$7.8 million to \$8.6 million per 0.1 mile. By comparison, this project is at \$6.88 million per 0.1 mile. The data on the right provides the Florida Department of Transportation’s current inflation cost factors.

Year	Inflation Factor
2022	2.7%
2023	2.8%
2024	2.9%
2025	3.0%
2026	3.1%
2027	3.2%
2028	3.3%
2029	3.3%
2030	3.3%

This difference can be attributed to the differences in our project, which requires more drainage work over a longer stretch, but at the same time will use less paver materials in favor of stamped concrete and other considerations.



### Roadway Assumptions

Given the invasive nature of the underground/subsurface improvements, including drainage needs across the corridor, the costs are likely to be more akin to LRE estimates for new constructions than a simple milling and resurfacing. The roadway costs were arrived at utilizing LRE estimates and the length of the segment.

### Lighting

Where necessary, such as for light posts/lighting, Area 12 of the Florida Department of Transportation historical cost items were utilized, with an assumed number of poles based on the corridor length and the need for higher numbers in some areas, including Colee Hammock, which due to higher pedestrian priority requires more light posts. However, it should be noted that this number is subject to change based on final design and this is a planning level estimate. Due to the higher-than-normal potential for design phase differences based on local conditions, and because the Department of Transportation light pole is based on standard and not a specifically designed pole for aesthetic reasons, a 15% contingency was applied here as well.

### Utilities

A base assumption of movement of poles was calculated for each segment of above ground utilities. Should above ground utilities be undergrounded, additional budgetary resources will be needed.

### Colee Hammock Considerations

#### Intersection Improvements

This estimate assumes raising of intersection at SE 12th Avenue, corrections to existing crossing at SE 13th Avenue, additional improvements to SE 15th Avenue for a dual left turn, SE 16th Avenue study (planning/traffic analysis cost is included) and potential adjustments, and closure at SE 17th Avenue. No widening of SE 15th Avenue, nor costs for improvements to 15th Avenue and Broward Boulevard, are considered here.

## Sospiro Bridge

Sospiro Bridge's base estimate includes the demolition and replacement of the existing bridge and a building of a new bridge. Estimate provided is based on the square footage of bridge and FDOT bridge construction estimates, and, as the bridge is constrained in terms of available right-of-way width, adjusted to account for land acquisition or the movement of large water mains to the north of the existing bridge.

## Las Olas Isles Considerations

### Roadway Raising and Drainage

It is clear based on an understanding of the area that the City will have to invest in the drainage of this roadway in the future to adequately address changing conditions and associated concerns. It is expected as part of the drainage improvements and roadway construction, and the City may elect to raise the roadway on the south side as well, which will also necessitate drainage and roadway improvements on the roadways to the south of Las Olas Boulevard.

### “Mid-block” Crossings

Pedestrians must be able to cross roads safely. Local governments have the obligation to provide safe and convenient crossing opportunities. Safety is never to be compromised to accommodate traffic flow. In general unsignalized crossings should occur on urban arterials with maximum speeds of 30 mph or 35 mph. In the Isles portion of the corridor this speed criteria is not met, as the speed limit is 35 mph while the actual speed is over 40

mph. To warrant unsignalized crossings, the speed must be brought down through some form of traffic calming, of which the lane narrowing from 11' to 10' is intended to do.

Multiple mid-block locations are recommended for the Las Olas Isles. Due to the current volume of traffic and rates of speeding, the overall recommendations for crosswalks, particularly in the isles, after warrant analyses are performed, point towards the necessity of some type of signalization warning motorists of pedestrian crossing. These may take the form of Rectangular Rapid Flashing Beacons (RRFB's), or Pedestrian Actuated Signals, where the lights stop automobile traffic to allow for pedestrians to cross. Unless speeds can be lowered this is the tradeoff for the desired crosswalks. Therefore, it will be unlike regular midblock crossing estimates, which are based on a minor intervention midblock, whereas the proposed improvements will be at intersections, with 4 mast arms at each of the 4 signals. By comparison, each mast arm for the improvements being conducted by Broward County at 15th Avenue and Broward Boulevard are estimated at approximately \$300,000 in construction cost. If the City can reduce the speed in the area, these improvements will be less costly as the City will have less expensive midblock crossing options that are not permissible under current engineering standards and current conditions.

### Bridges and Extensions

The seven bridges on the north side of Las Olas Boulevard have sight distance issues for which the primary conclusion is to adjust the bridge walls and provide for a widening at the Las Olas side with “sight triangle” extensions. These extensions are expected to have similar costs to a bridge

construction as an add-on to the bridge, with a 20% upward adjustment for phasing. However, it's also possible that all the bridges may need redesign and reconstruction. While one number is given in the report, the estimate range as a result is from \$750,000 to over \$7 million.

## Beach Considerations

### Roadway, Landscape, and Lighting Considerations

As the City has recently redesigned and constructed this area, our cost estimates only focus on the bridge cantilever.

### Bridge Cantilever

The bridge cantilever was estimated using the Florida Department of Transportation long range estimate, assuming the need for 10 feet on both sides of the bridge, over the length of the existing bridge. While 10 feet seems wide, the need for railings/separation reduces the actual usable pathway area, though for the purposes of construction the overall square footage remains higher. Taking the upper end of per square footage cost for movable bridges (\$2000/sq.

ft) per FDOT estimates, the calculation was then adjusted from construction to include PD&E, Design, etc. as previously mentioned. A high level of contingency is needed for the bridge cantilever because of the moving nature of the bridge; additional work may be needed to ensure the bridge can continue to raise, and other structural support may be necessary.

The following includes planning-level considerations of construction, PD&E, Design, CEI, Maintenance-of-Traffic costs, as well as contingency, adjusted to **2021 dollars**. Actual costs will be dependent on final-design considerations (including drainage) for the mile corridor, and year of construction.

	Colee Hammock	The Isles	The Beach	Total
<b>Streetscape</b>	\$1,751,825	\$6,569,343	\$-	\$8,321,168
<b>Landscaping</b>	\$4,080,964	\$4,947,336	\$-	\$9,028,300
<b>Lighting</b>	\$331,387	\$1,142,336	\$-	\$1,473,723
<b>Utilities</b>	\$218,978	\$802,920	\$-	\$1,021,898
<b>Bridges</b>	\$3,722,628	\$547,445	\$33,284,672	\$37,554,745
<b>Intersection and Midblock Improvements</b>	\$912,409	\$5,912,409	\$-	\$6,824,818
<b>Other (Subsurface, etc)</b>	\$364,964	\$10,948,905	\$-	\$11,313,869
<b>Design</b>	\$1,365,978	\$3,704,483	\$3,994,161	\$9,064,622
<b>CEI</b>	\$1,707,473	\$4,630,604	\$4,992,701	\$11,330,778
<b>Maintenance of Traffic (MOT)</b>	\$1,138,315	\$3,087,069	\$3,328,467	\$7,553,851
<b>Contingency</b>	\$1,559,492	\$4,229,285	\$4,560,000	\$10,348,777
<b>Total</b>	\$17,154,412	\$46,522,135	\$50,160,000	\$113,836,547

**"Las Olas will become a destination  
to serve residents and visitors alike.  
An active unique world class live,  
work and play street."**





CITY OF FORT LAUDERDALE

lasolas

**THE CORRADINO GROUP**