



BOARD OF ADJUSTMENT MEETING NOTICE

March 29, 2022

A Public Hearing will be held before the Board of Adjustment on:

Wednesday, April 13, 2022 at 6:00 P.M

This meeting will be held in the City Commission Chambers, City Hall, 1st Floor, 100 North Andrews Avenue, Fort Lauderdale, Florida 33301 to determine whether the following application should be granted:

CASE: PLN-BOA-22030006

OWNER: THRIVE DEVELOPMENT GROUP LLC

AGENT: CRUSH LAW, P.A. – JASON S. CRUSH, ESQ.

ADDRESS: 710-726 N.W. 5TH AVENUE, FORT LAUDERDALE, FL., 33311

LEGAL DESCRIPTION: **Parcel 5** Lots 22, 23, and 24, Block 282, "PROGRESSO", according to the Plat thereof, as recorded in Plat Book 2, Page 18, of the Public Records of Miami-Dade County, Florida; sold lands now situate, lying and being Broward County, Florida.

Parcel 6 Lots 25, 26, and 27, Block 282, of "PROGRESSO", according to the Plat thereof, as recorded in Plat Book 2, Page 15, of the Public Records of Miami-Dade County, Florida; sold lands now situate, lying and being in Broward County, Florida.

Parcel 7 Lots 21, 28, 29, 30, 31, 32, 33, 34, 35, 36, 37 and the East ½ of Lots 38, 39, 40, 41, and 42, , Block 282, of "PROGRESSO", according to the Plat thereof, as recorded in Plat Book 2, Page 18, of the Public Records of Miami Dade County, Florida; sold lands now situate, lying and being in Broward County, Florida.

Parcel 8 The West ½ of Lots 38, 39, 40, 41, and 42 and all of Lots 43, 44, 45, 46, 47 and 48, Block 282, of "PROGRESSO", according to the Plat thereof, as recorded in Plat Book 2, Page 18, of the Public Records of Miami-Dade County, Florida; sold lands now situate, lying and being in Broward County, Florida; sold lands now situate in Broward County, Florida.

ZONING DISTRICT: B-3 - Heavy Commercial/Light Industrial Business

COMMISSION DISTRICT: 2

REQUESTING:

Sec. 47-19.2. Z.1.- Roof mounted structures.

Requesting a variance to omit the required roof top equipment screening required to be of materials matching the construction of the building. The Developer wishes to paint murals matching the motif of the muralized building and roof.

Note: To view more information about this item, please visit: www.fortlauderdale.gov/government/BOA

If you have any questions, please feel free to contact me directly at 954-828-6342.

MOHAMMED MALIK
ZONING ADMINISTRATOR

Florida Statutes, Sec. 286.0105

NOTE: If any person decides to appeal any decision made with respect to any matter considered at this public meeting or hearing, he/she will need a record of the proceedings, and for such purpose, he/she may need to ensure that a verbatim record of the proceeding is made, which record includes the testimony and evidence upon which the appeal is to be based.

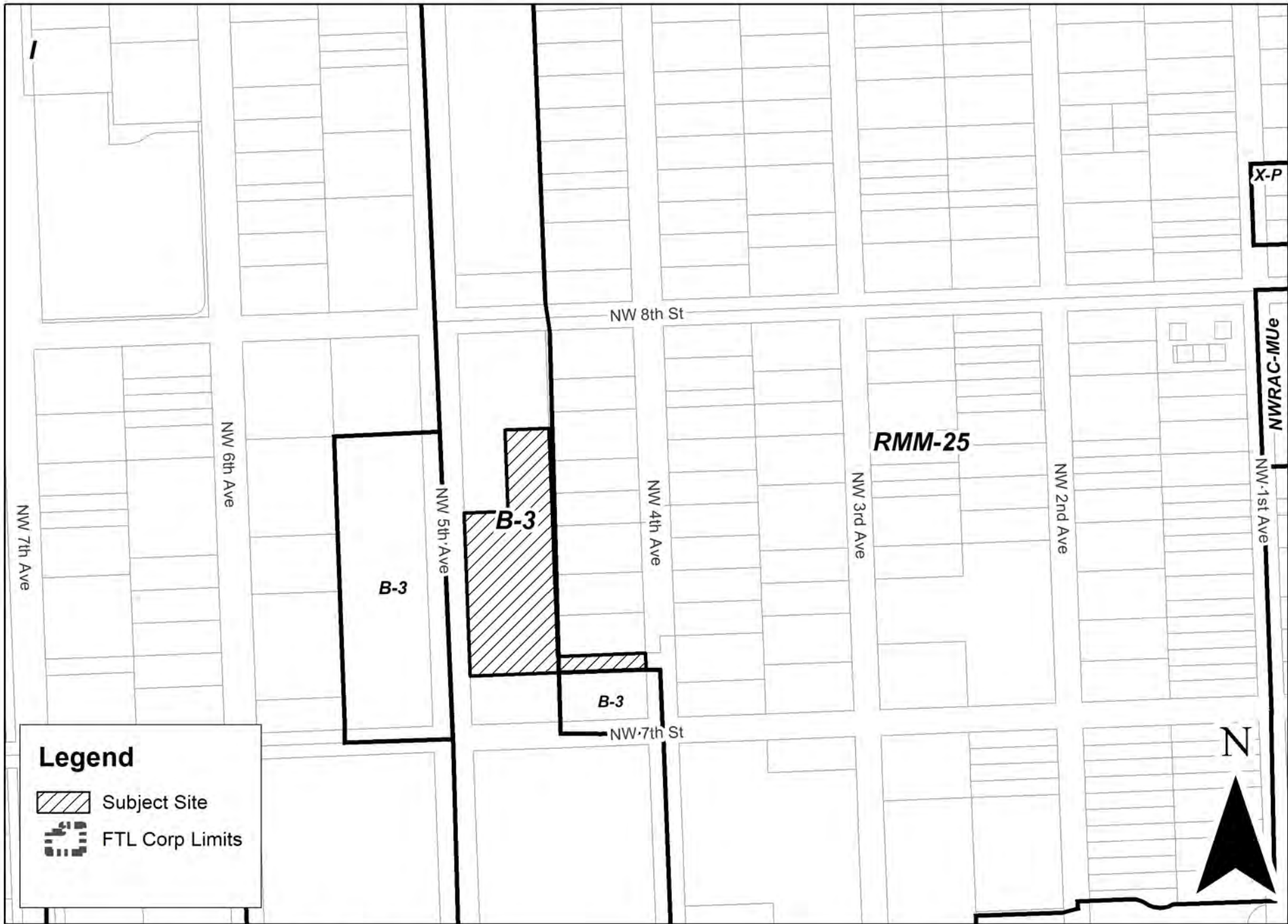

PLN-BOA-22030006

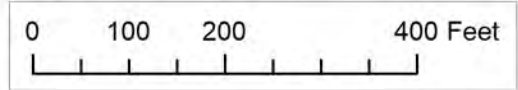

Graphic Scale



CITY OF FORT LAUDERDALE
PUBLIC NOTICE

BOARD OF ADJUSTMENT MEETING

DATE: APRIL 13, 2022

TIME: 6:00 PM

CASE: PLN-BOA-22030006

REQUESTING: Section 47-19.2. Z.1.- Roof mounted structures.

Requesting a variance to omit the required roof top equipment screening required to be of materials matching the construction of the building. The Developer wishes to paint murals matching the motif of the muralized building and roof.

LOCATION: CITY COMMISSION CHAMBERS
CITY HALL, 100 N ANDREWS AVENUE

INFORMATION: CONTACT (954) 828-6506
<http://www.fortlauderdale.gov>

This Notice is the property of the City of Fort Lauderdale. In accordance with City Code Section 16-29, It shall be unlawful for any person to injure, cut, break or destroy in any manner any building or other thing belonging to or under the control of the City. Persons marring or removing the Notice may be subject to fine and/or imprisonment.

In accordance with City Code Section 47-27.2A. H The sign shall remain on the property until final disposition of the application. This shall include any deferral, rehearing, appeal, request for review or hearing by another body. The sign information shall be changed as provided in subsection A.3.a



BOA

DATE: 04/13/2022

AGENDA ITEM: 10

CASE:

PLN-BOA-22030006



SUSTAINABLE DEVELOPMENT – ZONING & LANDSCAPING BOARD OF ADJUSTMENT (BOA) APPLICATION

Rev: 3 Revision Date: 05/17/2021 | Print Date: 05/17/2021
I.D. Number: Z&L-BOA

BOARD OF ADJUSTMENT (BOA) APPLICATION

Cover:	Deadline, Notes, and Fees
Page 1:	Applicant Information Sheet
Page 2:	Variance Request Criteria
Page 3:	Required Documentation & Mail Notice Requirements
Page 4:	Sign Notice Requirements & Affidavit
Page 5:	Technical Specifications

DEADLINE: Submittals must be received prior to 4:00 PM each business day. Pursuant to Section 47-24.12, the Department will review all applications to determine completeness within five (5) business days. Applicants will be notified via e-mail, if plans do not meet the submittal requirements and if changes are required.

APPLICATION SUBMITTAL: Submit your Board of Adjustment (BOA) application, required documents and fees online by visiting: <https://aca-prod.accela.com/FTL>. After application and document submission, you should receive a case number and will be invoiced for the fee amount due. Prior to formal submittal of applications, applicants are encouraged to schedule an appointment with the Board Liaison and staff to obtain feedback regarding proposals. The meetings provide an opportunity for applicants to obtain feedback and general direction, prior to expending significant effort on preparation of submittal documents. To request a meeting to discuss your variance request, please contact Chakila Crawford at chcrawford@fortlauderdale.gov and/or Stephanie Hughey at shughey@fortlauderdale.gov.

FEES: All applications for development permits are established by the City Commission, as set forth by resolution and amended from time to time. In addition to the application fee, any additional costs incurred by the City including review by a consultant on behalf of the City, or special advertising costs shall be paid by the applicant. Any additional costs, which are unknown at the time of application, but are later incurred by the City, shall be paid by the applicant prior to the issuance of a development permit.

- Variance/Special Exception/Interpretation (Before): **\$2,200**
- Variance/Special Exception/Interpretation (After): **\$2,800**
- Parking Variance (per space): **\$2,600**
- Variance/Special Exception/Interpretation (Before)- Residential Homesteaded Only- Accessory Structures & Existing Non-Conforming Structures: **\$650**
- Variance/Special Exception/Interpretation (After)- Residential Homesteaded Only- Accessory Structures & Existing Non-Conforming Structures: **\$850**
- Request for Continuance: **\$900**
- Request for Rehearing: **\$300**
- Rehearing before the Board: **\$1,150**

Page 1: BOA - Applicant Information Sheet

INSTRUCTIONS: The following information is requested pursuant to the City's Unified Land Development Regulations (ULDR). While the information requested in this application is the minimum required to proceed please be aware additional information may be required to fully address the variance requested. The application must be filled out accurately and completely. Please print or type and answer all questions. Indicate N/A if does not apply.

NOTE: To be filled out by Department

Case Number	
Date of complete submittal	

NOTE: For purpose of identification, the **PROPERTY OWNER** is the **APPLICANT**

Property Owner's Name	Thive Development Group, LLC
Property Owner's Signature	<small>If a signed agent letter is provided, no signature is required on this application by the owner.</small>
Address, City, State, Zip	9232 ABBOTT AVE MIAMI FL 33154
E-mail Address	jcrush@crushlaw.com
Phone Number	954.522.2010
Proof of Ownership	<input type="checkbox"/> Warranty Deed or <input checked="" type="checkbox"/> Tax Record

NOTE: If AGENT is to represent OWNER, notarized letter of consent is required

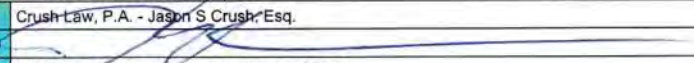
Applicant / Agent's Name	Crush Law, P.A. - Jason S. Crush, Esq.
Applicant / Agent's Signature	
Address, City, State, Zip	600 SE 2nd Court, Fort Lauderdale, FL 33301
E-mail Address	jcrush@crushlaw.com
Phone Number	954.522.2010
Letter of Consent Submitted	YES

Development / Project Name	Thrive East				
Existing / New	<table style="width: 100%; border: none;"> <tr> <td style="border: none;">Existing:</td> <td style="border: none; text-align: center;"><input checked="" type="checkbox"/></td> <td style="border: none;">New:</td> <td style="border: none; text-align: center;"><input type="checkbox"/></td> </tr> </table>	Existing:	<input checked="" type="checkbox"/>	New:	<input type="checkbox"/>
Existing:	<input checked="" type="checkbox"/>	New:	<input type="checkbox"/>		
Project Address	Address: 710-726 NW 5 AVENUE, FORT LAUDERDALE FL 33311				
Legal Description	PROGRESSO 2-18 D LOTS 21,28 THRU 37 AND E1/2 OF LOTS 38 THRU 42 BLK 282				
Tax ID Folio Numbers <small>(For all parcels in development)</small>	4942 34 07 0100				
Request / Description of Project	Variance to ULDR Sec 47-19.2.Z.1 - to use alternate method to screening for rooftop A/C equipment for renovated buildings				
Applicable ULDR Sections	ULDR Sec 47-19.2.Z.1				

Current Land Use Designation	RAC
Current Zoning Designation	B-3
Current Use of Property	Art District uses
Site Adjacent to Waterway	<input type="checkbox"/> Yes <input checked="" type="checkbox"/> No

Setbacks (indicate direction N, S, E, W)	Required	Proposed
Front <input type="checkbox"/>	Existing - No Change	Existing - No Change
Side <input type="checkbox"/>	Existing - No Change	Existing - No Change
Side <input type="checkbox"/>	Existing - No Change	Existing - No Change
Rear <input type="checkbox"/>	Existing - No Change	Existing - No Change

Page 2: Board of Adjustment (BOA) Criteria for Variance Request

Complete this page and an attached narrative.

SPECIFIC REQUEST: State the specific request according to the ULDR or other provisions of the Code.

See attached Narrative

CRITERIA: Applicant must demonstrate a unique hardship attributable to the land by proving by a preponderance of the evidence for all of the following criteria. Please answer the following criteria completely. While some criteria may seem duplicative the response should be tailored specifically to each. Per section 47-24.12, A.4,

a. Special conditions and circumstances affect the property at issue which prevent the reasonable use of such property; and

See attached Narrative

b. Circumstances which cause the special conditions are peculiar to the property at issue, or to such a small number of properties that they clearly constitute marked exceptions to other properties in the same zoning district; and

See attached Narrative

c. Literal application of the provisions of the ULDR would deprive the applicant of a substantial property right that is enjoyed by other property owners in the same zoning district. (It shall be of no importance to this criterion that a denial of the variance sought might deny to the owner a more profitable use of the property, provided the provisions of the ULDR still allow a reasonable use of the property; and

See attached Narrative

d. The unique hardship is not self-created by the applicant or his predecessors, nor is it the result of mere disregard for, or ignorance of, the provisions of the ULDR or antecedent zoning regulations; and

See attached Narrative

e. The variance is the minimum variance that will make possible a reasonable use of the property and that the variance will be in harmony with the general purposes and intent of the ULDR and the use as varied will not be incompatible with adjoining properties or the surrounding neighborhood or otherwise detrimental to the public welfare.

See attached Narrative

AFFIDAVIT: I, Jason S Crush the Owner/Agent of said property ATTEST that I am aware of the following:

1. In order to be entitled to the relief requested in the application an affirmative vote of a majority plus one of the Board of Adjustment is required;
2. That in granting the relief requested, the Board of Adjustment is limited to the authority vested in the Board by the ULDR and that the Board may not grant the relief requested unless the applicant proves all the criteria specified in the ULDR have been met;
3. That the granting of relief by the Board does not exempt the applicant or owner of record from the responsibilities of obtaining all applicable permits or approvals as may be required by law for both new and existing structures;
4. That if the relief requested is granted by the Board, the applicant must secure a building permit to implement the relief requested within one hundred eighty (180) days of the entry of the final order or the Board, or within such lesser time as the Board may proscribe and that failure to procure the necessary permits within the time so proscribed shall render the variance or special exception null and void;
5. That if the Board denies the request for relief, then no additional application for the same or substantially the same relief may be entertained by the Board within two (2) years of the date of entry of the final order of denial.

(Signature)

SWORN TO AND SUBSCRIBED before me in the County and State above aforesaid this 4 day of March, 2025

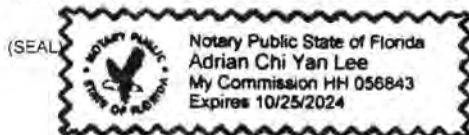

NOTARY PUBLIC
MY COMMISSION EXPIRES:

Page 3: Required Documentation & Mail Notice Requirements

One (1) original set, signed and sealed, with plans at 24" x 36"

One (1) electronic version (CD or USB) of complete application and plans in PDF format

Fourteen (14) copy sets of each item below and plans at half-size scale 11" x 17"

- Completed application** (all pages must be filled out where applicable)
- Mail notification documents** (mail notification instructions at bottom of page)
- Proof of ownership** (warranty deed, Sunbiz and/or tax record), including corporation documents if applicable
- Property owners original notarized signature** and/or notarized agent letter signed by the property owner (if applicable)
- Color photographs** of the entire property and all surrounding properties, dated and labeled and identified as to orientation
- Narrative** describing specific request and outlining ULDR sections that are applicable. Narratives must be on letterhead, dated, and with author indicated.
- Cover sheet** on plan set to state project name and table of contents.
- Current survey(s)** of property, signed and sealed, showing existing conditions; survey must be As-Built with Right-of-Way and Easement Vacations Excluded. The survey should consist of the proposed project site alone. Do not include adjacent properties or portions of lands not included in the proposed project unless specifically requested by the City. If the survey is not signed and sealed, a zoning affidavit is required and shall only be used for the structures listed in the affidavit.
- Site Plan** (a survey may be substituted if the requested variance is clearly indicated)
- Landscape Plan** (if applicable)
- Elevations** (if applicable)
- Additional Plan details as needed**

Note: All copy sets must be clear and legible.

Note: Plans must be folded to 8 ½" x 11". All non-plan documents should be 8 ½" x 11".



MAIL NOTIFICATION: Pursuant to Section 47-27.2 Types of Public Notice and 47-27.9 Variance, Special Exception, Temporary Non-Conforming Use, Interpretation requires the following notice:

- **MAIL NOTICE:** Mail notice shall be given to owners of land within three hundred (300) feet of the subject site ten (10) days prior to the date set for the public hearing.
 - **TAX MAP:** Applicant shall provide a tax map from the Broward County Property Appraiser of all property within a three hundred (300) foot radius, with each property clearly shown and delineated. Each property within the notice area must be numbered (by Folio ID) on the map to cross-reference with property owners notice list.
 - **PROPERTY OWNERS NOTICE LIST:** Applicant shall provide a property owner notice list with the names, property control numbers (Folio ID) and complete addresses for all property owners within the required three hundred (300) foot radius. The list shall also include all homeowners' associations, condominium associations, municipalities and counties noticed, as indicated on the tax roll.
 - **ENVELOPES:** The applicant shall provide business size (#10) envelopes with first class postage attached (stamps only, metered mail will not be accepted). Envelopes must be addressed to all property owners within the required three hundred (300) foot radius, and mailing addresses must be typed or labeled; no handwritten addresses will be accepted. The return address shall be listed on all envelopes as follows:

**City of Fort Lauderdale
Urban Design & Development -BOA
700 NW 19th Avenue, Fort Lauderdale, FL 33311**

- **DISTRIBUTION:** The City of Fort Lauderdale, Urban Design & Development will mail all notices prior to the public hearing meeting date, as outlined in Section 47-27.
- **HOW TO ORDER A TAX MAP AND MAIL NOTICE LIST:** To order a tax map and notice list, please email Heather Hanson at hhanson@bcpa.net or call 954-357-6855. You may also contact Kenny Gibbs, kgibbs@bcpa.net or call 954-357-5503.

SIGN NOTICE

Applicant must **POST SIGNS** (for Board of Adjustment) according to Sec. 47-27.2 Types of Public Notice and 47-27.9 Variance, Special Exception, Temporary Non-Conforming Use, Interpretation requires the following notice:

- Sign Notice shall be given by the applicant by posting a sign provided by the City stating the time, date, and place of the Public Hearing on such matter on the property which is the subject of an application for a development permit. If more than one (1) public hearing is held on a matter, the date, time, and place shall be stated on the sign or changed as applicable.
- The sign shall be posted at least fifteen (15) days prior to the date of the public hearing.
- The sign shall be visible from adjacent rights-of-way, including waterways, but excepting alleys.
- If the subject property is on more than one (1) right-of-way, as described above, a sign shall be posted facing each right-of-way.
- If the applicant is not the owner of the property that is subject of the application, the applicant shall post the sign on or as near to the subject property as possible subject to the permission of the owner of the property where the sign is located or, in a location in the right-of-way if approved by the City.
- If the sign is destroyed or removed from the property, the applicant is responsible for obtaining another sign from the City and posting the sign on the property.
- The sign shall remain on the property until final disposition of the application. This shall include any deferral, rehearing, appeal, request for review or hearings by another body. The sign information shall be changed as above to reflect any new dates.
- The applicant shall, five (5) days prior to the public hearing, execute and submit to the department an affidavit of proof of posting of the public notice sign according to this section. If the applicant fails to submit the affidavit the public hearing will be postponed until the next hearing after the affidavit has been supplied.

AFFIDAVIT OF POSTING SIGNS

STATE OF FLORIDA

BROWARD COUNTY

BOA CASE NO. _____

APPLICANT: _____

PROPERTY: _____

PUBLIC HEARING DATE: _____

BEFORE ME, the undersigned authority, personally appeared _____, who upon being duly sworn and cautioned, under oath deposes and says:

1. Affiant is the Applicant in the above cited City of Fort Lauderdale **Board or Commission** Case.
2. The Affiant/Applicant has posted or has caused to be posted on the Property the signage provided by the City of Fort Lauderdale, which such signage notifies the public of the time, date and place of the Public Hearing on the application for relief before the **Board or Commission**.
3. That the sign(s) referenced in Paragraph two (2) above was posted on the Property in such manner as to be visible from adjacent streets and waterways and was posted at least **fifteen (15)** days prior to the date of the Public Hearing cited above and has remained continuously posted until the date of execution and filing of this Affidavit. Said sign(s) shall be visible from and within twenty (20) feet of streets and waterways, and shall be securely fastened to a stake, fence, or building.
4. Affiant acknowledges that the sign must remain posted on the property until the final disposition of the case before the **Board or Commission**. **Should the application be continued, deferred, or re-heard, the sign shall be amended to reflect the new dates.**
5. Affiant acknowledges that this Affidavit must be executed and filed with the City's Urban Design & Development **five (5)** calendar days prior to the date of Public Hearing and if the Affidavit is not submitted, the Public Hearing on this case shall be cancelled.
6. Affiant is familiar with the nature of an oath or affirmation and is familiar with the laws of perjury in the State of Florida and the penalties, therefore.

NOTE: I understand that if my sign is not returned within the prescribed time limit as noted in Sec. 47.27.2.j of the City of Fort Lauderdale ULDR, I will forfeit my sign deposit. _____ (initial here)

Affiant

SWORN TO AND SUBSCRIBED before me in the County and State above aforesaid this _____ day of _____, 20__

(SEAL)

NOTARY PUBLIC
MY COMMISSION EXPIRES:

Page 5: Technical Specifications

A. SITE PLAN

1. Title Block including project name and design professional's address and phone number
2. Scale (1" = 30' min., must be engineer's scale)
3. North indicator
4. Location map showing relationship to major arterials
5. Drawing and revision dates, as applicable
6. Full legal description
7. Site Plan Data Table
 - Current use of property
 - Land Use designation
 - Zoning designation
 - Site area (sq. ft. and acres)
 - Setback table (required vs. provided)
 - Open space
8. Site Plan Features (graphically indicated)
 - Setbacks and building separations (dimensioned)
 - Project signage (if applicable)
 - Easements (as applicable)

(Please note additional site plan information may be necessary to fully address the requested variance)

B. BUILDING ELEVATIONS (as applicable)

1. All building facades with directional labels (i.e. North, South) and building names if more than one building
2. Dimensions, including height and width of all structures
3. Dimensions of setbacks and required setbacks from property lines
4. Dimension grade at crown of road, at curb, sidewalk, building entrance, and finished floor
5. Include proposed signage



**THRIVE EAST
NARRATIVE
Variance Request
710-726 NW 5 Avenue
Fort Lauderdale, FL 33311**

Background:

Thrive East is a rehabilitation project converting once dilapidated warehouses to a multi-use art district located at 710-726 NW 5 Avenue. The property is located in the City's B-3 Light Industrial/Heavy Commercial zoning district and is mostly surrounded by industrial uses. The property owner seeks a variance to Section 47-19.2.Z.1 of the ULDR to allow an alternative to strict compliance with the City of Fort Lauderdale's ("City") rooftop screening requirements.

Thrive East is being developed with Thrive West – which is across the street from Thrive East and both properties work in conjunction to create an "Art District" in this industrial area.

Thrive East is comprised of single-story buildings with artistic murals around the entirety. The change of use and renovation was approved by the City's Development Review Committee ("DRC") on November 13, 2020. Roof top equipment screening was not requested by the DRC at that time.

The intention for the project is to create an art district feel for multiple uses providing vibrant murals and an artistic feel. The owner's intention for the rooftop equipment is to complement the building murals with artistic mini-murals on the equipment in keeping with the murals on the facades of the buildings. This project is located in the City's B-3 (Light Industrial) zoning district and the "Industrial" turned Artistic feel is the motif that is desired.

Code Provision:

Specifically, Section 47-19.2.Z.1 provides:

1. *Roof mounted structures such as air conditioners and satellite dish antennae shall be required to be screened with material that matches the material used for the principal structure and shall be at least six (6) inches high above the top most surface of the roof mounted structure. Vent pipes, skylights, cupolas, solar collectors and chimneys shall not be subject to this provision.*

Variance Criteria:

4. *Criteria—Variance. A variance from the terms of the ULDR shall be granted only upon demonstrating a unique hardship attributable to the land by proving by a preponderance of the evidence all of the following criteria:*
 - a. *That special conditions and circumstances affect the property at issue which prevent the reasonable use of such property; and*

Response: The purpose of Sections 47-19.2.Z.1 in the ULDR is to mitigate the visibility of rooftop mechanical equipment. Here, visual impact of muralized rooftop mechanical equipment is what is desired to complement the overall “vibe” of the entire project. Providing generic screening would detract from the intended aesthetic of the project.

- b. *That the circumstances which cause the special conditions are peculiar to the property at issue, or to such a small number of properties that they clearly constitute marked exceptions to other properties in the same zoning district; and*

Response: Thrive East is a renovation of an existing structure in a light industrial district. Here, the screening requirements of Sec 47-19.Z.1 are being retroactively applied to this exiting building due to its change of use from industrial uses to it proposed desirable uses.

- c. *That the literal application of the provisions of the ULDR would deprive the applicant of a substantial property right that is enjoyed by other property owners in the same zoning district.*

Response: In this instance, literal application of the ULDR provision would increase the mass of the buildings and thwart the intention of providing an alternative method to the screening requirement to mitigate the appearance of the equipment. Further, surrounding industrial properties have un-screened rooftop mounted equipment.

- d. *That the unique hardship is not self-created by the applicant or his predecessors, nor is it the result of mere disregard for, or ignorance of, the provisions of the ULDR or antecedent zoning regulations; and*

Response: This unique hardship is not self-created by the applicant, nor is it the result of mere disregard for the ULDR. Rather, the property owner diligently submitted a site plan and City staff reviewed and approved the application. Further, the literal application of the ULDR would prevent the intended muralizing of the roof top equipment to create the intended look and feel of the project.

- e. *That the variance is the minimum variance that will make possible a reasonable use of the property and that the variance will be in harmony with the general purposes and intent of the ULDR and the use as varied will not be incompatible with adjoining properties or the surrounding neighborhood or otherwise detrimental to the public welfare.*

Response: The variance is the minimum variance that will make possible a reasonable use of the property. The variance will be in harmony with the general purpose and intent of the ULDR, as the purpose of the code section is to mitigate mechanical equipment where hear the art mitigates the equipment by providing a cohesive look and feel to the project.

PLN-BOA-22030006

Sec. 47-19.2. Z.1.- Roof mounted structures.

(Z). *Roof mounted structures.*

(1). Roof mounted structures such as air conditioners and satellite dish antennae shall be required to be screened with material that matches the material used for the principal structure and shall be at least six (6) inches high above the top most surface of the roof mounted structure. Vent pipes, skylights, cupolas, solar collectors and chimneys shall not be subject to this provision.

SIGN NOTICE

Applicant must **POST SIGNS** (for Board of Adjustment) according to Sec. 47-27.2 Types of Public Notice and 47-27.9 Variance, Special Exception, Temporary Non-Conforming Use, Interpretation requires the following notice:

- Sign Notice shall be given by the applicant by posting a sign provided by the City stating the time, date, and place of the Public Hearing on such matter on the property which is the subject of an application for a development permit. If more than one (1) public hearing is held on a matter, the date, time, and place shall be stated on the sign or changed as applicable.
- The sign shall be posted at least fifteen (15) days prior to the date of the public hearing.
- The sign shall be visible from adjacent rights-of-way, including waterways, but excepting alleys.
- If the subject property is on more than one (1) right-of-way, as described above, a sign shall be posted facing each right-of-way.
- If the applicant is not the owner of the property that is subject of the application, the applicant shall post the sign on or as near to the subject property as possible subject to the permission of the owner of the property where the sign is located or, in a location in the right-of-way if approved by the City.
- If the sign is destroyed or removed from the property, the applicant is responsible for obtaining another sign from the City and posting the sign on the property.
- The sign shall remain on the property until final disposition of the application. This shall include any deferral, rehearing, appeal, request for review or hearings by another body. The sign information shall be changed as above to reflect any new dates.
- The applicant shall, five (5) days prior to the public hearing, execute and submit to the department an affidavit of proof of posting of the public notice sign according to this section. If the applicant fails to submit the affidavit the public hearing will be postponed until the next hearing after the affidavit has been supplied.

AFFIDAVIT OF POSTING SIGNS

STATE OF FLORIDA

BROWARD COUNTY

BOA CASE NO. PLN-BOA-22030006

APPLICANT: Thrive Development Group, LLC

PROPERTY: 710-726 NW 5th Avenue

PUBLIC HEARING DATE: April 13, 2022

BEFORE ME, the undersigned authority, personally appeared Jason S. Crush, who upon being duly sworn and cautioned, under oath deposes and says:

1. Affiant is the Applicant in the above cited City of Fort Lauderdale **Board or Commission** Case.
2. The Affiant/Applicant has posted or has caused to be posted on the Property the signage provided by the City of Fort Lauderdale, which such signage notifies the public of the time, date and place of the Public Hearing on the application for relief before the **Board or Commission**.
3. That the sign(s) referenced in Paragraph two (2) above was posted on the Property in such manner as to be visible from adjacent streets and waterways and was posted at least **fifteen (15)** days prior to the date of the Public Hearing cited above and has remained continuously posted until the date of execution and filing of this Affidavit. Said sign(s) shall be visible from and within twenty (20) feet of streets and waterways, and shall be securely fastened to a stake, fence, or building.
4. Affiant acknowledges that the sign must remain posted on the property until the final disposition of the case before the **Board or Commission**. **Should the application be continued, deferred, or re-heard, the sign shall be amended to reflect the new dates.**
5. Affiant acknowledges that this Affidavit must be executed and filed with the City's Urban Design & Development **five (5)** calendar days prior to the date of Public Hearing and if the Affidavit is not submitted, the Public Hearing on this case shall be cancelled.
6. Affiant is familiar with the nature of an oath or affirmation and is familiar with the laws of perjury in the State of Florida and the penalties, therefore.

NOTE: I understand that if my sign is not returned within the prescribed time limit as noted in Sec. 47.27.2.j of the City of Fort Lauderdale ULDR, I will forfeit my sign deposit. (Initial here)

Affiant

SWORN TO AND SUBSCRIBED before me in the County and State above aforesaid this 30 day of March, 2022

(SEAL)

Lauren N. Ramos

NOTARY PUBLIC

MY COMMISSION EXPIRES: March 16, 2024

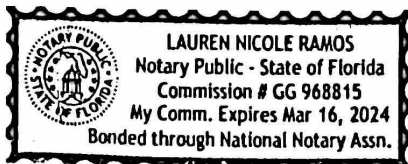



0 37.575 150 225 300
Feet

MARTY KIAR
BROWARD COUNTY PROPERTY APPRAISER



THRIVE EAST
DATE OF PRINT: 03/02/2022

FOLIO_NUMB	NAME_LINE_	NAME_LINE1	ADDRESS_LI	CITY	STATE	ZIP
494234063870	HICKMAN,NANCY DIANE		8010 NW 46 CT	LAUDERHILL	FL	33351
494234064110	807 NW 4TH AVE LLC		807 NW 4 AVE #1-4	FORT LAUDERDALE	FL	33311
494234064140	DRAGOSLAVIC,GORAN		1800 W BROWARD BLVD	FORT LAUDERDALE	FL	33312
494234064150	BEMBANASTE,JAMES		1808 SW 10 AVE	FORT LAUDERDALE	FL	33315
494234064160	320 HENDRICKS ISLES LLC		2030 INTRACOASTAL DR	FORT LAUDERDALE	FL	33305
494234064570	MARLENE THOMAS REV TR	THOMAS,MARLENE TRSTEE	1990 SW 30 TER	FORT LAUDERDALE	FL	33312
494234069410	JPG BELL PROPERTY LLC		PO BOX 950	FORT LAUDERDALE	FL	33302
494234069460	THRIVE DEVELOPMENT GROUP LLC		9232 ABBOTT AVE	MIAMI	FL	33154
494234069630	DREAM BUILDERS TR	LAND TRUST SERVICE CORP TRSTEE	PO BOX 186	LAKE WALES	FL	33859
494234069640	724 NW 6TH AVE LLC		746 NW 5 AVE	FORT LAUDERDALE	FL	33311
494234069641	708 NW 6TH AVE LLC		746 NW 5 AVE	FORT LAUDERDALE	FL	33311
494234069650	CASALE,ROSANNE D		1271 NW 95 AVE	PLANTATION	FL	33322
494234069760	JPG BELL PROPERTY LLC		PO BOX 950	FORT LAUDERDALE	FL	33302
494234070010	1004 NW 6TH ST LLC		746 NW 5 AVE	FORT LAUDERDALE	FL	33311
494234070020	VIGNATI,MARIA		444 NE 9 AVE	FORT LAUDERDALE	FL	33301
494234070030	JFX4 INVESTMENTS LLC		400 BONAVENTURE BLVD	WESTON	FL	33326
494234070060	CECH,CHRISTIAN		731 NW 4 AVE #4	FORT LAUDERDALE	FL	33311
494234070080	HEGU LLC		5772 SW 31 ST	MIAMI	FL	33155
494234070100	THRIVE DEVELOPMENT GROUP LLC		9232 ABBOTT AVE	MIAMI	FL	33154
494234070110	THRIVE DEVELOPMENT GROUP LLC		9232 ABBOTT AVE	SURFSIDE	FL	33154
494234070120	THRIVE DEVELOPMENT GROUP LLC		9232 ABBOTT AVE	SURFSIDE	FL	33154
494234070200	THRIVE DEVELOPMENT GROUP LLC		746 NW 5 AVE	FORT LAUDERDALE	FL	33311
494234070340	WILBERT RAYNER REV LIV TR	CHRISTINE R RAYNER REV LIV TR	6120 CYPRESS RD	PLANTATION	FL	33317
494234070380	REED,VERNELL		700 NW 4 AVE	FORT LAUDERDALE	FL	33311
494234070390	FORT LAUDERDALE COMMUNITY	REDEVELOPMENT AGENCY	100 N ANDREWS AVE	FORT LAUDERDALE	FL	33301
494234070410	HOUSING AUTHORITY OF THE	CITY OF FORT LAUDERDALE	437 SW 4 AVE	FORT LAUDERDALE	FL	33315
494234070430	JOHNSON,AYTIAH T		730 NW 4 AVE #4	FORT LAUDERDALE	FL	33311
494234070450	COMMUNITY 8 PROPERTIES LLC		1800 W BROWARD BLVD	FORT LAUDERDALE	FL	33312
494234070460	COMMUNITY 8 PROPERTIES LLC		1800 W BROWARD BLVD	FORT LAUDERDALE	FL	33312
494234070470	740 NW 4TH AVENUE LLC		200 E LAS OLAS BLVD STE 1550	FORT LAUDERDALE	FL	33301
494234070480	WALCOTT,ART		PO BOX 9011	CORAL SPRINGS	FL	33075
494234076700	VILLADA PROPERTIES LLC		4533 N ANDREWS AVE	OAKLAND PARK	FL	33309
494234076940	FIRST EBENEZER MISSIONARY	CHRISTIAN CHURCH INC	1510 NW 11 AVE	FORT LAUDERDALE	FL	33311
494234076950	DIXIE INVESTMENTS IV LLC		101 S FT LAUD BEACH BLVD #1103	FORT LAUDERDALE	FL	33316
494234077250	CFP 500 LLC		PO BOX 967	FORT LAUDERDALE	FL	33302
494234110150	MERIDIAN PARTNERS 2 LLC		PO BOX 670867	CORAL SPRINGS	FL	33067
494234110180	STS GROUP USA INC		1001 N FEDERAL HWY # 318	HALLANDALE BEACH	FL	33009
494234110190	REAL ESTATE SERVICES & MGMT INC	% BRIAN FRIEDMAN	151 N NOB HILL RD #373	PLANTATION	FL	33324
494234110320	BROWN,TANISHA		719 NW 3 AVE	FORT LAUDERDALE	FL	33311
494234110321	LASLEY,DEBBIE BROWN H/E	LASLEY,ELBERT	715 NW 3 AVE	FORT LAUDERDALE	FL	33311
494234110322	HILL-WILLIAMS,VALERIE		711 NW 3 AVE	FORT LAUDERDALE	FL	33311
494234110330	HOUSING AUTHORITY OF THE	CITY OF FORT LAUDERDALE	437 SW 4 AVE	FORT LAUDERDALE	FL	33315
494234110332	SHALOMMAX LLC		1800 W BROWARD BLVD	FORT LAUDERDALE	FL	33312
494234110350	THROUGH HIS GRACE 2 LLC		6511 NOVA DR #171	DAVIE	FL	33317
494234110360	MERIDIAN PARTNERS 2 LLC		PO BOX 670867	CORAL SPRINGS	FL	33067

ADDRESS__1	LEGAL_LINE	LEGAL_LI_1	LEGAL_LI_2	LEGAL_LI_3
LAUDERHILL FL33351	PROGRESSO 2-18 D	LOT 25,26 BLK 262		
FORT LAUDERDALE FL33311	PROGRESSO 2-18 D	LOT 20,21,22 BLK 263		
FORT LAUDERDALE FL33312	PROGRESSO 2-18 D	LOT 23,24 BLK 263		
FORT LAUDERDALE FL33315	PROGRESSO 2-18 D	LOT 25,26 BLK 263		
FORT LAUDERDALE FL33305	PROGRESSO 2-18 D	LOTS 27 THRU 48 & VAC S1/2	OF W 127.50 OF NW 9 ST	ABUTTING SAID LOT,AND 79-40
FORT LAUDERDALE FL33312	PROGRESSO 2-18 D	LOTS 18 THRU 24 BLK 264		
FORT LAUDERDALE FL33302	PROGRESSO 2-18 D	LOT 1 THRU 6 BLK 281		
MIAMI FL33154	PROGRESSO 2-18 D	LOTS 7 THRU 24 BLK 281		
LAKE WALES FL33859	PROGRESSO 2-18 D	LOT 25,26 BLK 281		
FORT LAUDERDALE FL33311	PROGRESSO 2-18 D	LOT 33 LESS S 12 1/2,34 THRU 36	BLK 281	
FORT LAUDERDALE FL33311	PROGRESSO 2-18 D	LOTS 27 THRU 32,33 S1/2	BLK 281	
PLANTATION FL33322	PROGRESSO 2-18 D	LOT 37 TO 42 BLK 281		
FORT LAUDERDALE FL33302	PROGRESSO 2-18 D	LOTS 43 THRU 48 BLK 281		
FORT LAUDERDALE FL33311	PROGRESSO 2-18 D	LOT 1 TO 3 BLK 282		
FORT LAUDERDALE FL33301	PROGRESSO 2-18 D	LOTS 4 & 5 BLK 282		
WESTON FL33326	PROGRESSO 2-18 D	LOT 6,7,8 BLK 282		
FORT LAUDERDALE FL33311	PROGRESSO 2-18 D	LOT 9,10 BLK 282		
MIAMI FL33155	PROGRESSO 2-18 D	LOT 11,12 BLK 282		
MIAMI FL33154	PROGRESSO 2-18 D	LOTS 21,28 THRU 37 AND E1/2 OF	LOTS 38 THRU 42 BLK 282	
SURFSIDE FL33154	PROGRESSO 2-18 D	LOT 22 TO 24 BLK 282		
SURFSIDE FL33154	PROGRESSO 2-18 D	LOT 25 TO 27 BLK 282		
FORT LAUDERDALE FL33311	PROGRESSO 2-18 D	LOTS 43 THRU 48 AND W1/2 OF	LOTS 38 THRU 42 BLK 282	
PLANTATION FL33317	PROGRESSO 2-18 D	LOTS 11,12,13,14 BLK 283		
FORT LAUDERDALE FL33311	PROGRESSO 2-18 D	LOT 25,26,27 S 3 BLK 283		
FORT LAUDERDALE FL33301	PROGRESSO 2-18 D	LOT 27 LESS S 3,LOTS 28 & 29	BLK 283	
FORT LAUDERDALE FL33315	PROGRESSO 2-18 D	LOT 38,39 BLK 283		
FORT LAUDERDALE FL33311	PROGRESSO 2-18 D	LOT 40,41 BLK 283		
FORT LAUDERDALE FL33312	PROGRESSO 2-18 D	LOT 42,43 BLK 283		
FORT LAUDERDALE FL33312	PROGRESSO 2-18 D	LOT 44 BLK 283		
FORT LAUDERDALE FL33301	PROGRESSO 2-18 D	LOT 45,46 BLK 283		
CORAL SPRINGS FL33075	PROGRESSO 2-18 D	LOT 47,48 BLK 283		
OAKLAND PARK FL33309	PROGRESSO 2-18 D	LOT 1,2 BLK 322		
FORT LAUDERDALE FL33311	PROGRESSO 2-18 D	LOTS 3 THRU 12,14 S 4,15,16,35,	36,39 THRU 48 BLK 322 & LOTS 22	THRU 24 BLK 283
FORT LAUDERDALE FL33316	PROGRESSO 2-18 D	LOTS 1 THRU 16 & 32 THRU 48	BLK 323	
FORT LAUDERDALE FL33302	PROGRESSO 2-18 D	LOT 1 TO 13,36 TO 48 BLK 324		
CORAL SPRINGS FL33067	PROGRESSO 1-107 D	LOT 13,14,15 BLK 282		
HALLANDALE BEACH FL33009	PROGRESSO 1-107 D	LOT 16,17,N1/2 18 BLK 282		
PLANTATION FL33324	PROGRESSO 1-107 D	LOT 18 S1/2,19,20 BLK 282		
FORT LAUDERDALE FL33311	PROGRESSO 1-107 D	LOT 15,16 BLK 283		
FORT LAUDERDALE FL33311	PROGRESSO 1-107 D	LOT 17,18 BLK 283		
FORT LAUDERDALE FL33311	PROGRESSO 1-107 D	LOTS 19,20,21 BLK 283		
FORT LAUDERDALE FL33315	PROGRESSO 1-107 D	LOTS 30 & 31 BLK 283		
FORT LAUDERDALE FL33312	PROGRESSO 1-107 D	LOTS 32 & 33 BLK 283		
DAVIE FL33317	PROGRESSO 1-107 D	LOT 34,35 BLK 283		
CORAL SPRINGS FL33067	PROGRESSO 1-107 D	LOT 36,37 BLK 283		

LEGAL_LI_4

LEGAL_LI_5

LEGAL_LI_6

LEGAL_LI_7

BLK 263

LEGAL_LI_8

LEGAL_LI_9

LEGAL_L_10

LEGAL_L_11

LEGAL_L_12

LEGAL_L_13

ZIP4	MILL	US	US	M/	C/	JUST_LAND	JUST_BUILD	JUST_OTHE	LY_JUSTVAL	LY_SOHL	LY_SOHB	PREV_SOH	NEW_SOH
5618	0312	00	02			135000	0	0	87750	0	0	37630	41390
	0312	08	04	02		50630	339940	0	317170	0	0	317170	348880
	0312	01	01	02		13500	37850	0	51230	0	0	49130	51350
	0312	08	02	02		33750	210090	0	224630	0	0	224630	243840
	0312	48	01	02		768010	3182990	0	3951000	0	0	3587960	3946750
	0312	48	01	02		236250	799460	0	1035710	0	0	1035710	1035710
	0312	48	01	02		202510	861020	0	1063530	0	0	1041090	1063530
	0312	48	01	02		1209580	680630	0	3221110	0	0	3221110	1890210
	0312	48	01	02		67500	515890	0	583390	0	0	583390	583390
	0312	48	01	02		118130	964040	0	1082170	0	0	709690	780650
	0312	48	01	02		219380	1130350	0	1349730	0	0	1349730	1349730
	0312	48	01	02		202500	842070	0	1044570	0	0	1044570	1044570
	0312	49	01	02		263250	31670	0	294920	0	0	283330	294920
	0312	01	01	02		50630	219170	0	263690	0	0	263690	269800
	0312	01	01	02		33750	133800	0	155680	0	0	155680	167550
	0312	08	02	02		50630	189910	0	220920	0	0	220920	240540
	0312	08	04	02		33750	500060	0	279450	0	0	279450	533810
4014	0312	08	04	02		33750	480460	0	297700	0	0	297700	514210
	0312	48	01	02		820130	360290	0	1896700	0	0	1756830	1180420
	0312	00	02			202500	0	0	131630	0	0	77690	85450
3012	0312	10	02			182250	0	0	182250	0	0	167060	182250
	0312	48	01	02		294040	741050	0	1023540	0	0	1023540	1035090
	0312	03	01	02		67500	699040	0	766540	0	0	729170	766540
7324	0312	01	01	02		39350	364250	0	403600	0	0	81710	84160
	0312	80	02			126360	0	0	126360	0	0	64680	71140
	0312	08	04	02		33750	80740	0	114490	0	0	114490	114490
	0312	08	04	02		33750	260050	0	271660	33750	36540	230540	247660
	0312	08	05	02		33750	424840	0	373680	0	0	348150	382960
	0312	00	02			67500	0	0	43880	0	0	29190	32100
2238	0312	08	04	02		33750	340330	0	297480	0	0	297480	327220
	0312	01	01	02		37120	243950	0	281070	0	0	281070	281070
3919	0312	08	04	02		33760	339750	0	309880	0	0	309880	340860
	0312	71	01	02		481240	1252450	0	1733690	0	0	1733690	1733690
	0312	48	01	02		1113750	2302240	0	3415990	0	0	3415990	3415990
	0312	48	01	02		899440	546100	0	1445540	0	0	1445540	1445540
	0312	08	04	02		50630	340130	0	315090	0	0	315090	346590
	0312	08	03	02		42190	315200	0	315120	0	0	207510	228260
	0312	08	03	02		42190	314620	0	306280	0	0	189580	208530
	0312	01	01	02		37130	219460	0	253760	0	0	75770	78040
	0312	01	01	02		37130	187940	0	222490	0	0	81090	83520
	0312	01	01	02		55690	201190	0	254190	0	0	89510	92190
	0312	08	04	02		33750	379830	0	370880	0	0	270850	297930
	0312	08	04	02		33750	379460	0	371740	0	0	275930	303520
	0312	08	04	02		33750	500180	0	281640	0	0	281640	533930
	0312	08	04	02		33750	379840	0	366030	0	0	331440	364580

NEW_SB_SC	HE1_AMOU	HE2_AMOU	WVD_AMO	EXEMPTION	COUNTY_M	SCHOOL_M	CITY_MEX_	INDEP_MEX	COUNTY_T	SCHOOL_T	CITY_TAXA	INDEP_TAX	HE_LY_F	ME_W	EXISO	CO	FID	DEL_VALUE	
135000	0	0	0	0	0	0	0	0	41390	135000	41390	41390					08	Y	0
390570	0	0	0	0	0	0	0	0	348880	390570	348880	348880					18	Y	0
51350	0	0	0	0	0	0	0	0	51350	51350	51350	51350					10	Y	0
243840	0	0	0	0	0	0	0	0	243840	243840	243840	243840					18	Y	0
3951000	0	0	0	0	0	0	0	0	3946750	3951000	3946750	3946750					16	Y	0
1035710	0	0	0	0	0	0	0	0	1035710	1035710	1035710	1035710					08	E Y	0
1063530	0	0	0	0	0	0	0	0	1063530	1063530	1063530	1063530					19	Y	0
1890210	0	0	0	0	0	0	0	0	1890210	1890210	1890210	1890210					17	S Y	0
583390	0	0	0	0	0	0	0	0	583390	583390	583390	583390					19	Y	0
1082170	0	0	0	0	0	0	0	0	780650	1082170	780650	780650					20	Y	0
1349730	0	0	0	0	0	0	0	0	1349730	1349730	1349730	1349730					21	Y	0
1044570	0	0	0	0	0	0	0	0	1044570	1044570	1044570	1044570					13	E Y	0
294920	0	0	0	0	0	0	0	0	294920	294920	294920	294920					19	Y	0
269800	0	0	0	0	0	0	0	0	269800	269800	269800	269800					20	Y	0
167550	0	0	0	0	0	0	0	0	167550	167550	167550	167550					18	Y	0
240540	0	0	0	0	0	0	0	0	240540	240540	240540	240540					18	Y	0
533810	0	0	0	0	0	0	0	0	533810	533810	533810	533810					22	Y	0
514210	0	0	0	0	0	0	0	0	514210	514210	514210	514210					22	Y	0
1180420	0	0	0	0	0	0	0	0	1180420	1180420	1180420	1180420					18	S Y	0
202500	0	0	0	0	0	0	0	0	85450	202500	85450	85450					19	Y	0
182250	0	0	0	0	0	0	0	0	182250	182250	182250	182250					19	Y	0
1035090	0	0	0	0	0	0	0	0	1035090	1035090	1035090	1035090					19	Y	0
766540	0	0	0	0	0	0	0	0	766540	766540	766540	766540					08	Y	0
84160	25000	25000	500	0	0	0	0	0	33660	58660	33660	33660	1/1	1/1	1	94	08	Y	0
126360	0	0	0	0	71140	126360	71140	71140	0	0	0	0			100	15	18	Y	0
114490	0	0	0	296360	114490	114490	114490	114490	0	0	0	0			100	15	08	G Y	0
266420	25000	21380	0	0	0	0	0	0	201280	241420	201280	201280	100	100		16	16	Y	0
458590	0	0	0	0	0	0	0	0	382960	458590	382960	382960					18	Y	0
67500	0	0	0	0	0	0	0	0	32100	67500	32100	32100					18	Y	0
374080	0	0	0	0	0	0	0	0	327220	374080	327220	327220					16	Y	0
281070	0	0	0	0	0	0	0	0	281070	281070	281070	281070					22	Y	0
373510	0	0	0	0	0	0	0	0	340860	373510	340860	340860					20	Y	0
1733690	0	0	0	1568230	1733690	1733690	1733690	1733690	0	0	0	0			100	30	08	Y	0
3415990	0	0	0	0	0	0	0	0	3415990	3415990	3415990	3415990					08	Y	0
1445540	0	0	0	0	0	0	0	0	1445540	1445540	1445540	1445540					19	Y	0
390760	0	0	0	0	0	0	0	0	346590	390760	346590	346590					16	Y	0
357390	0	0	0	0	0	0	0	0	228260	357390	228260	228260					16	Y	0
356810	0	0	0	0	0	0	0	0	208530	356810	208530	208530					13	Y	0
78040	25000	25000	0	0	0	0	0	0	28040	53040	28040	28040	1/1	1/1		00	08	Y	0
83520	25000	25000	0	0	0	0	0	0	0	58520	0	33520	1/1	1/1		00	08	Y	0
92190	25000	25000	0	0	0	0	0	0	42190	67190	42190	42190	1/1	1/1		00	08	Y	0
413580	0	0	0	248270	297930	413580	297930	297930	0	0	0	0			100	15	08	Y	0
413210	0	0	0	0	0	0	0	0	303520	413210	303520	303520					14	Y	0
533930	0	0	0	0	0	0	0	0	533930	533930	533930	533930					22	Y	0
413590	0	0	0	0	0	0	0	0	364580	413590	364580	364580					16	Y	0

ADD_VALUE	LI	GARBAGE_AS	FIR	FIRE_ASSES	SAI	SAFE_NEI_1	DR	DRAINAGE_1	IM	IMPROVEM_	SALE_DATE	DEE	STAMP	AMC	BOOK_1	PAGE_1	SALE_DATE	DEE
0	F	0.00	03	L	1	0	0.00	0.00	0.00	#####	QCD	0.70	24737.00	0000000000	114.00	0000000000	#####	QCD
0	F	29.28	03	R	4	0	0.00	0.00	0.00	#####	WD	2345.00	0.00	0000000000	0.00	0000000000	#####	WD'
0	F	9.44	03	R	1	0	0.00	0.00	0.00	#####	DRR	0.00	46383.00	0000000000	1772.00	0000000000	6/1/2009	WD
0	F	14.64	03	R	2	0	0.00	0.00	0.00	#####	WD	1679.30	0.00	0000000000	0.00	0000000000	#####	QCD
0	F	76.56	03	V	43998	0	0.00	0.00	0.00	#####	SWI	32830.00	0.00	0000000000	0.00	0000000000	#####	WD
0	F	18.95	03	V	10893	0	0.00	0.00	0.00	#####	QCD	0.70	0.00	0000000000	0.00	0000000000	#####	WD
0	F	16.12	03	V	9262	0	0.00	0.00	0.00	4/5/2018	WD'	8505.00	0.00	0000000000	0.00	0000000000	#####	WD'
0	F	56.03	03	V	32202	0	0.00	0.00	0.00	#####	WD	18900.00	0.00	0000000000	0.00	0000000000	#####	QC*
0	F	11.27	03	V	6476	0	0.00	0.00	0.00	#####	WD	2520.00	0.00	0000000000	0.00	0000000000	#####	WD
0	F	11.77	03	V	6764	0	0.00	0.00	0.00	#####	WD	5250.00	0.00	0000000000	0.00	0000000000	#####	QCD
0	F	22.21	03	V	12767	0	0.00	0.00	0.00	6/5/2020	WD	10500.00	0.00	0000000000	0.00	0000000000	2/1/1989	WD
0	F	20.95	03	V	12042	0	0.00	0.00	0.00	6/8/2012	PRD	0.00	48881.00	0000000000	394.00	0000000000	#####	QCD
0	F	0.00	03	L	1	0	0.00	0.00	0.00	4/5/2018	WD'	8505.00	0.00	0000000000	0.00	0000000000	#####	WD'
0	F	9.44	03	R	1	0	0.00	0.00	0.00	#####	WD	1120.00	0.00	0000000000	0.00	0000000000	#####	D
0	F	9.44	03	R	1	0	0.00	0.00	0.00	#####	WD	1120.00	0.00	0000000000	0.00	0000000000	#####	TXD
0	F	14.64	03	R	2	0	0.00	0.00	0.00	#####	QCD	0.70	0.00	0000000000	0.00	0000000000	#####	WD
0	F	29.28	03	R	4	0	0.00	0.00	0.00	#####	WD	4368.00	0.00	0000000000	0.00	0000000000	#####	WD
0	F	29.28	03	R	4	0	0.00	0.00	0.00	#####	WD	3990.00	0.00	0000000000	0.00	0000000000	#####	WD
0	F	30.06	03	V	17277	0	0.00	0.00	0.00	#####	WD	9100.00	0.00	0000000000	0.00	0000000000	#####	WD
0	F	0.00	03	L	1	0	0.00	0.00	0.00	#####	WD	1575.00	0.00	0000000000	0.00	0000000000	#####	WD
0	F	0.00	03	L	1	0	0.00	0.00	0.00	#####	WD	1260.00	0.00	0000000000	0.00	0000000000	5/6/2013	QCD
0	F	18.74	03	V	10770	0	0.00	0.00	0.00	#####	WD	10500.00	0.00	0000000000	0.00	0000000000	#####	WD
0	F	54.40	03	R	10	0	0.00	0.00	0.00	#####	WD'	3360.00	37220.00	0000000000	1995.00	0000000000	#####	
0	F	9.44	03	R	1	0	0.00	0.00	0.00	7/1/1976	WD	72.00	6675.00	0000000000	67.00	0000000000	#####	
0		0.00	03	X	1	0	0.00	0.00	0.00	#####	QCD	0.70	0.00	0000000000	0.00	0000000000	#####	CET
0		0.00	03	R	4	0	0.00	0.00	0.00	8/9/2001	D	623.00	32117.00	0000000000	1181.00	0000000000	4/3/2001	SWI
0	F	29.28	03	R	4	0	0.00	0.00	0.00	1/9/2015	WD	1575.00	0.00	0000000000	0.00	0000000000	#####	WD
0	F	36.60	03	R	5	0	0.00	0.00	0.00	#####	WD'	1750.00	0.00	0000000000	0.00	0000000000	#####	WD'
0	F	0.00	03	L	1	0	0.00	0.00	0.00	#####	WD'	1750.00	0.00	0000000000	0.00	0000000000	#####	WD'
0	F	29.28	03	R	4	0	0.00	0.00	0.00	#####	QCD	0.70	0.00	0000000000	0.00	0000000000	#####	WD
0	F	9.44	03	R	1	0	0.00	0.00	0.00	#####	WD	1743.00	0.00	0000000000	0.00	0000000000	#####	QCD
0	F	29.28	03	R	4	0	0.00	0.00	0.00	#####	QCD	0.70	0.00	0000000000	0.00	0000000000	#####	WD
0	F	44.85	03	Y	6453	0	0.00	0.00	0.00	#####	WD	467.50	14700.00	0000000000	733.00	0000000000	#####	
0	F	108.87	03	V	62568	0	0.00	0.00	0.00	#####	WD'	0.70	40341.00	0000000000	157.00	0000000000	#####	WD
0	F	19.35	03	V	11119	0	0.00	0.00	0.00	4/4/2018	WD	18427.50	0.00	0000000000	0.00	0000000000	2/9/2007	QCD
0	F	29.28	03	R	4	0	0.00	0.00	0.00	#####	QCD	0.70	0.00	0000000000	0.00	0000000000	5/2/2014	WD
0	F	21.96	03	R	3	0	0.00	0.00	0.00	9/9/2015	WD	1029.00	0.00	0000000000	0.00	0000000000	#####	SWI
0	F	21.96	03	R	3	0	0.00	0.00	0.00	#####	SWI	360.50	49162.00	0000000000	469.00	0000000000	#####	CET
0	F	9.44	03	R	1	0	0.00	0.00	0.00	#####	WD	350.00	30037.00	0000000000	443.00	0000000000	#####	WD'
0	F	9.44	03	R	1	0	0.00	0.00	0.00	#####	QCD	101.50	45834.00	0000000000	828.00	0000000000	#####	QCD
0	F	9.44	03	R	1	0	0.00	0.00	0.00	#####	WD	350.00	30037.00	0000000000	406.00	0000000000	#####	
0		0.00	03	R	4	0	0.00	0.00	0.00	#####	DRR	262.50	32193.00	0000000000	1521.00	0000000000	#####	D
0	F	29.28	03	R	4	0	0.00	0.00	0.00	4/4/2013	WD	819.00	49686.00	0000000000	1034.00	0000000000	#####	WD
0	F	29.28	03	R	4	0	0.00	0.00	0.00	#####	WD	3955.00	0.00	0000000000	0.00	0000000000	#####	WD
0	F	29.28	03	R	4	0	0.00	0.00	0.00	#####	QCD	0.70	0.00	0000000000	0.00	0000000000	5/2/2014	WD

STAMP_AM_BOOK_2	PAGE_2	SALE_DAT_DEE	STAMP_AM_BOOK_3	PAGE_3	SALE_DAT_DEE	STAMP_AM_BOOK_4
0.70	21322.0000000000	614.0000000000	0.00	0.0000000000	0.0000000000	0.0000000000
1470.00	34308.0000000000	651.0000000000	##### TD*	931.00	32534.0000000000	1084.0000000000
217.00	46308.0000000000	1769.0000000000	##### D	1169.00	45521.0000000000	887.0000000000
0.70	0.0000000000	0.0000000000	##### QCC	0.70	0.0000000000	0.0000000000
25200.00	44968.0000000000	1845.0000000000	##### SWI	215.60	26281.0000000000	119.0000000000
5250.00	41394.0000000000	314.0000000000	9/9/2003 QCC	0.70	36084.0000000000	265.0000000000
3609.20	45219.0000000000	790.0000000000	##### D*	2800.00	28898.0000000000	1471.0000000000
0.70	45861.0000000000	1597.0000000000	##### WD'	11608.80	38559.0000000000	1800.0000000000
171.00	10249.0000000000	812.0000000000	0.00	0.0000000000	0.0000000000	0.0000000000
0.70	28361.0000000000	485.0000000000	##### WD	660.00	15410.0000000000	763.0000000000
1237.50	16249.0000000000	71.0000000000	6/1/1987 WD	1200.00	0.0000000000	0.0000000000
0.70	31477.0000000000	672.0000000000	8/1/1993 WD	1225.00	21141.0000000000	616.0000000000
3609.20	45219.0000000000	790.0000000000	##### D*	2800.00	28898.0000000000	1471.0000000000
280.00	31897.0000000000	723.0000000000	##### SWI	0.00	31163.0000000000	691.0000000000
323.40	0.0000000000	0.0000000000	3/1/1992 QCC	0.60	19230.0000000000	306.0000000000
1512.00	0.0000000000	0.0000000000	##### WD	882.00	34209.0000000000	280.0000000000
1890.00	0.0000000000	0.0000000000	##### QCC	0.70	44794.0000000000	544.0000000000
2520.00	0.0000000000	0.0000000000	6/6/2016 WD	1820.00	0.0000000000	0.0000000000
5775.00	36877.0000000000	304.0000000000	##### WD	4655.00	33744.0000000000	942.0000000000
728.00	49850.0000000000	1712.0000000000	##### WD	588.00	49459.0000000000	467.0000000000
0.70	49790.0000000000	284.0000000000	##### TXD	364.00	49253.0000000000	871.0000000000
3570.00	0.0000000000	0.0000000000	##### TD	0.70	0.0000000000	0.0000000000
0.00	0.0000000000	0.0000000000	##### WD'	3351.60	35467.0000000000	1894.0000000000
0.00	0.0000000000	0.0000000000	0.00	0.0000000000	0.0000000000	0.0000000000
0.70	23703.0000000000	965.0000000000	##### QCC	8.80	18032.0000000000	647.0000000000
0.70	31734.0000000000	243.0000000000	##### CET	0.70	31475.0000000000	203.0000000000
1190.00	49881.0000000000	669.0000000000	5/9/2005 WD	2100.00	39623.0000000000	1527.0000000000
1330.00	49222.0000000000	552.0000000000	6/6/2011 SW*	630.00	47963.0000000000	770.0000000000
1330.00	49222.0000000000	552.0000000000	6/6/2011 SW*	630.00	47963.0000000000	770.0000000000
1692.60	0.0000000000	0.0000000000	##### WD	0.70	0.0000000000	0.0000000000
0.70	0.0000000000	0.0000000000	##### WD	511.00	50697.0000000000	1616.0000000000
2380.00	0.0000000000	0.0000000000	##### WD	1680.00	0.0000000000	0.0000000000
0.00	0.0000000000	0.0000000000	0.00	0.0000000000	0.0000000000	0.0000000000
6680.10	20485.0000000000	846.0000000000	0.00	0.0000000000	0.0000000000	0.0000000000
0.70	43603.0000000000	334.0000000000	3/1/1994 QCC	0.70	21827.0000000000	952.0000000000
1235.50	50784.0000000000	246.0000000000	##### WD	476.00	31036.0000000000	23.0000000000
490.70	47922.0000000000	657.0000000000	9/8/2010 CET	0.70	47397.0000000000	448.0000000000
0.70	47300.0000000000	499.0000000000	##### WD	1802.50	38687.0000000000	1889.0000000000
331.10	28990.0000000000	804.0000000000	0.00	0.0000000000	0.0000000000	0.0000000000
0.70	34264.0000000000	839.0000000000	##### WD	371.00	30026.0000000000	1860.0000000000
0.00	0.0000000000	0.0000000000	0.00	0.0000000000	0.0000000000	0.0000000000
343.00	31897.0000000000	725.0000000000	1/5/2001 SWI	0.00	31161.0000000000	1560.0000000000
714.00	49249.0000000000	776.0000000000	6/3/2004 WD	1953.00	37611.0000000000	733.0000000000
1032.50	49748.0000000000	1838.0000000000	6/1/2010 QCC	700.00	47118.0000000000	1864.0000000000
1235.50	50784.0000000000	163.0000000000	##### SW*	560.00	30608.0000000000	502.0000000000

PAGE_4	SALE_DAT	DEE	STAMP_AM	BOOK_5	PAGE_5	LAND_CALC_	LAND_CALC1	LAI	LAND_CAL_2	LAND_CAL_3	LAI	LAND_CAL_5
0.0000000000			0.00		0.0000000000	20.00	6750.00	SF	0.00	0.00		0.00
0.0000000000			0.00		0.0000000000	5.00	10125.00	SF	0.00	0.00		0.00
1634.0000000000	7/7/2004	WD	909.30	37819.0000000000	1458.0000000000	2.00	6750.00	SF	0.00	0.00		0.00
0.0000000000	#####	SWI	644.00	0.0000000000	0.0000000000	5.00	6750.00	SF	0.00	0.00		0.00
388.0000000000	2/1/1993	TD*	5600.00	0.0000000000	0.0000000000	10.00	76801.00	SF	0.00	0.00		0.00
224.0000000000	#####	QCD	0.70	35495.0000000000	222.0000000000	10.00	23625.00	SF	0.00	0.00		0.00
722.0000000000			0.00	0.0000000000	0.0000000000	10.00	20251.00	SF	0.00	0.00		0.00
567.0000000000			0.00	0.0000000000	0.0000000000	18.00	60749.00	SF	0.00	0.00		0.00
0.0000000000			0.00	0.0000000000	0.0000000000	10.00	6750.00	SF	0.00	0.00		0.00
0.0000000000	#####	SD	48.15	0.0000000000	0.0000000000	10.00	11813.00	SF	0.00	0.00		0.00
0.0000000000			0.00	0.0000000000	0.0000000000	10.00	21938.00	SF	0.00	0.00		0.00
0.0000000000	2/1/1983	WD	1012.50	0.0000000000	0.0000000000	10.00	20250.00	SF	0.00	0.00		0.00
799.0000000000	2/1/1971	WD	10.74	3312.0000000000	910.0000000000	13.00	20250.00	SF	0.00	0.00		0.00
1907.0000000000	#####	QCD	0.70	21262.0000000000	316.0000000000	5.00	10126.00	SF	0.00	0.00		0.00
471.0000000000	#####	WD	70.50	0.0000000000	0.0000000000	5.00	6750.00	SF	0.00	0.00		0.00
1647.0000000000	6/4/1996	WD	280.00	24999.0000000000	367.0000000000	5.00	10125.00	SF	0.00	0.00		0.00
657.0000000000	#####	WD	1656.20	36639.0000000000	1952.0000000000	5.00	6750.00	SF	0.00	0.00		0.00
135.0000000000	#####	SWI	595.00	46123.0000000000	1268.0000000000	5.00	6750.00	SF	0.00	0.00		0.00
1490.0000000000	2/6/1996	QC*	0.70	24531.0000000000	525.0000000000	18.00	45563.00	SF	0.00	0.00		0.00
1645.0000000000	#####	CET	0.70	47007.0000000000	105.0000000000	20.00	10125.00	SF	0.00	0.00		0.00
1698.0000000000	7/1/1989	CET	0.55	16604.0000000000	198.0000000000	18.00	10125.00	SF	0.00	0.00		0.00
205.0000000000	#####	WD	1925.00	29600.0000000000	1307.0000000000	10.25	20250.00	SF	10.25	8437.00	SF	0.00
1785.0000000000	9/1/1994	QC*	0.70	22630.0000000000	122.0000000000	5.00	13500.00	SF	0.00	0.00		0.00
0.0000000000			0.00	0.0000000000	0.0000000000	5.50	7155.00	SF	0.00	0.00		0.00
0.0000000000	9/1/1978	WD	59.70	0.0000000000	0.0000000000	13.00	9720.00	SF	0.00	0.00		0.00
1824.0000000000	3/5/1999	SWI	0.00	29892.0000000000	488.0000000000	5.00	6750.00	SF	0.00	0.00		0.00
1716.0000000000	#####	QCD	0.70	33813.0000000000	313.0000000000	5.00	6750.00	SF	0.00	0.00		0.00
97.0000000000	7/1/2010	D*	0.70	47314.0000000000	1135.0000000000	5.00	6750.00	SF	0.00	0.00		0.00
97.0000000000	7/1/2010	D*	0.70	47314.0000000000	1135.0000000000	20.00	3375.00	SF	0.00	0.00		0.00
445.0000000000	4/5/2011	CET	415.80	47881.0000000000	1040.0000000000	5.00	6750.00	SF	0.00	0.00		0.00
19.0000000000	#####	QCD	161.00	48804.0000000000	649.0000000000	5.50	6749.00	SF	0.00	0.00		0.00
1222.0000000000	#####	SWI	595.00	48765.0000000000	1765.0000000000	5.00	6751.00	SF	0.00	0.00		0.00
0.0000000000			0.00	0.0000000000	0.0000000000	5.25	91664.00	SF	0.00	0.00		0.00
0.0000000000			0.00	0.0000000000	0.0000000000	10.00	111375.00	SF	0.00	0.00		0.00
0.0000000000	#####	SWI	3162.50	0.0000000000	0.0000000000	10.25	87750.00	SF	0.00	0.00		0.00
671.0000000000	#####	WD	1351.00	27994.0000000000	866.0000000000	5.00	10125.00	SF	0.00	0.00		0.00
1852.0000000000	1/5/2004	WD	1330.00	36795.0000000000	1481.0000000000	5.00	8437.00	SF	0.00	0.00		0.00
1105.0000000000	#####	WD	595.00	32479.0000000000	1258.0000000000	5.00	8438.00	SF	0.00	0.00		0.00
0.0000000000			0.00	0.0000000000	0.0000000000	5.50	6750.00	SF	0.00	0.00		0.00
0.0000000000			0.00	0.0000000000	0.0000000000	5.50	6750.00	SF	0.00	0.00		0.00
0.0000000000			0.00	0.0000000000	0.0000000000	5.50	10125.00	SF	0.00	0.00		0.00
113.0000000000	#####	WD	875.00	27140.0000000000	457.0000000000	5.00	6750.00	SF	0.00	0.00		0.00
1575.0000000000	#####	WD	1400.00	34937.0000000000	1766.0000000000	5.00	6750.00	SF	0.00	0.00		0.00
1361.0000000000	4/3/2009	SWI	486.50	46231.0000000000	1384.0000000000	5.00	6750.00	SF	0.00	0.00		0.00
134.0000000000	#####	WD'	875.00	27140.0000000000	657.0000000000	5.00	6750.00	SF	0.00	0.00		0.00

LAND_CAL_6	LAI	LAND_CAL_8	LAND_CAL_9	LAI	SITUS_S	SITUS_S	SIT	SITUS_ST_4	SITUS	SIT	SITUS_ZIP_	SITUS_	LAST_YRS_J	LAST_YRS_1	LAST_YRS_2	LAST_YRS_1	LAST_YRS_A
0.00		0.00	0.00	800			NW	4	AVE	FL	333117215		87750	0	0	37630	110968
0.00		0.00	0.00	807			NW	4	AVE	FL	33311	1-4	50630	266540	0	317170	777783
0.00		0.00	0.00	801			NW	4	AVE	FL	33311		13500	37730	0	49130	149407
0.00		0.00	0.00	477			NW	8	ST	FL	33311	1-2	33750	190880	0	224630	528715
0.00		0.00	0.00	820	880		NW	5	AVE	FL	33311		768010	3182990	0	3587960	7633810
0.00		0.00	0.00	805			NW	5	AVE	FL	33311		236250	799460	0	1035710	2130131
0.00		0.00	0.00	520			NW	8	ST	FL	33311		202510	861020	0	1041090	2096919
0.00		0.00	0.00	701	745		NW	5	AVE	FL	33311		607490	2613620	0	3221110	6470723
0.00		0.00	0.00	702			NW	6	AVE	FL	333117332		67500	515890	0	583390	1153205
0.00		0.00	0.00	724			NW	6	AVE	FL	333117332		118130	964040	0	709690	1662592
0.00		0.00	0.00	708	718		NW	6	AVE	FL	33311		219380	1130350	0	1349730	2705135
0.00		0.00	0.00	728			NW	6	AVE	FL	33311		202500	842070	0	1044570	2129794
0.00		0.00	0.00	750			NW	6	AVE	FL	33311		263250	31670	0	283330	638671
0.00		0.00	0.00	745			NW	4	AVE	FL	33311		50630	213060	0	263690	546013
0.00		0.00	0.00	741			NW	4	AVE	FL	333117344		33750	121930	0	155680	345677
0.00		0.00	0.00	733	735		NW	4	AVE	FL	33311		50630	170290	0	220920	521834
0.00		0.00	0.00	731			NW	4	AVE	FL	33311	1-4	33750	245700	0	279450	690208
0.00		0.00	0.00	725			NW	4	AVE	FL	33311	1-4	33750	263950	0	297700	724060
0.00		0.00	0.00	710	726		NW	5	AVE	FL	33311		455630	1441070	0	1756830	3712365
0.00		0.00	0.00	405			NW	7	ST	FL	33311		131630	0	0	77690	192135
0.00		0.00	0.00	413	415		NW	7	ST	FL	33311		182250	0	0	167060	332855
0.00		0.00	0.00	744	748		NW	5	AVE	FL	33311		294040	729500	0	1023540	2133886
0.00		0.00	0.00	721			NW	3	AVE	FL	33311		67500	699040	0	729170	1780837
0.00		0.00	0.00	700			NW	4	AVE	FL	333117324		39350	364250	0	31210	130971
0.00		0.00	0.00				NW	4	AVE	FL	33311		126360	0	0	0	0
0.00		0.00	0.00	728			NW	4	AVE	FL	33311	1-4	33750	80740	0	0	0
0.00		0.00	0.00	730			NW	4	AVE	FL	33311	1-4	33750	237910	0	185250	540355
0.00		0.00	0.00	734			NW	4	AVE	FL	33311	1-5	33750	339930	0	348150	868297
0.00		0.00	0.00				NW	4	AVE	FL	33311		43880	0	0	29190	68028
0.00		0.00	0.00	740			NW	4	AVE	FL	33311	1-4	33750	263730	0	297480	723651
0.00		0.00	0.00	360			NW	8	ST	FL	33311		37120	243950	0	260340	553194
0.00		0.00	0.00	647			NW	3	AVE	FL	33311	1-4	33760	276120	0	309880	746654
0.00		0.00	0.00	312			NW	7	ST	FL	33311		481240	1252450	0	0	497105
0.00		0.00	0.00	635	695		NW	4	AVE	FL	33311		1113750	2302240	0	3415990	7429993
0.00		0.00	0.00	520			NW	7	ST	FL	33311		899440	546100	0	1445540	3225055
0.00		0.00	0.00	721			NW	4	AVE	FL	33311	1-4	50630	264460	0	315090	773923
0.00		0.00	0.00	713			NW	4	AVE	FL	33311	1-3	42190	272930	0	207510	622539
0.00		0.00	0.00	711			NW	4	AVE	FL	33311	1-3	42190	264090	0	189580	595156
0.00		0.00	0.00	719			NW	3	AVE	FL	33311		37130	216630	0	25770	120878
0.00		0.00	0.00	715			NW	3	AVE	FL	33311		37130	185360	0	0	99501
0.00		0.00	0.00	711			NW	3	AVE	FL	33311		55690	198500	0	39510	146362
0.00		0.00	0.00	712			NW	4	AVE	FL	33311	1-4	33750	337130	0	0	0
0.00		0.00	0.00	716			NW	4	AVE	FL	33311	1-4	33750	337990	0	275930	745592
0.00		0.00	0.00	720			NW	4	AVE	FL	33311	1-4	33750	247890	0	232100	634397
0.00		0.00	0.00	724			NW	4	AVE	FL	33311	1-4	33750	332280	0	331440	808991

LAST_YRS_S	TWO_YRS_J	TWO_YRS_T	TWO_YRS_T	TWO_YRS_T	TWO_YRS_A	TWO_YRS_S	BLDG_ADJ_S	BLDG_TOT_S	BLDG_UNIT	BLDG_BLD_B	BLDG_BLD_H	NCU_LAND	NCU_BLDG	NCULY_M	A_DATE
37630	81000	0	0	34210	102341	34210	0	0	0	0	0	N	0	0	1/1 1/1 101009
317170	50630	266430	0	317060	774474	317060	2717	2717	4	1964	003 2	1 100	N	0	0 1/1 1/1 101009
49130	13500	37000	0	44670	143134	44670	784	859	1	1960	003 2	1 001	N	0	0 1/1 1/1 101009
224630	33750	188220	0	221970	521607	221970	2200	2200	2	1977	003 2	1 100	N	0	0 1/1 1/1 101009
3587960	768010	2742390	0	3261790	6924034	3261790	43998	43998	0	1983	003 2	1 500	N	0	0 1/1 1/1 101009
1035710	236250	751970	0	988220	2032374	988220	10893	10893	0	1975	003 2	1 500	N	0	0 1/1 1/1 101009
1041090	202510	815880	0	946450	1944416	946450	9262	9262	0	1950	003 2	1 500	N	0	0 1/1 1/1 101009
3221110	607490	2469510	0	3077000	6173306	3077000	32202	32202	0	1974	003 2	2 500	N	0	0 1/1 1/1 101009
583390	67500	482410	0	549910	1085723	549910	6476	6476	0	1957	003 2	2 500	N	0	0 1/1 1/1 101009
709690	118130	527050	0	645180	1295926	645180	6764	6764	0	1958	003 2	1 500	N	0	0 1/1 1/1 101009
1349730	219380	994760	0	934630	2107893	934630	12767	12767	0	1958	003 2	1 500	N	0	0 1/1 1/1 101009
1044570	202500	769050	0	971550	1984846	971550	12042	12042	0	1959	003 2	1 500	N	0	0 1/1 1/1 101009
283330	243000	31670	0	257580	592016	257580	0	0	0	1990	003 2	0 409	N	0	0 1/1 1/1 101009
263690	50630	208850	0	259480	535663	259480	897	1092	1	1954	003 2	1 001	N	0	0 1/1 1/1 101009
155680	33750	119520	0	153270	339710	153270	995	1064	1	1957	003 2	1 001	N	0	0 1/1 1/1 101009
220920	50630	167190	0	217820	513953	217820	2009	2009	2	1958	003 2	1 100	N	0	0 1/1 1/1 101009
279450	33750	246010	0	266040	671655	266040	2543	2543	4	1955	003 2	1 100	N	0	0 1/1 1/1 101009
297700	33750	263950	0	297700	721145	297700	2543	2543	4	1963	003 2	1 100	N	0	0 1/1 1/1 101009
1756830	455630	1195240	0	1597120	3345084	1597120	17277	17277	0	1984	003 2	4 500	N	0	0 1/1 1/1 101009
77690	55690	164310	0	220000	519751	220000	0	0	0	0	003 2	0 102	N	0	0 1/1 1/1 101203
167060	151880	0	0	151880	293395	151880	0	0	0	0	005 2	0 000	N	0	0 1/1 1/1 101009
1023540	294040	729800	0	1008090	2105605	1008090	10770	10770	0	1980	003 2	1 500	N	0	0 1/1 1/1 101009
729170	67500	682480	0	662890	1683919	662890	7343	7343	10	1974	003 2	1 100	N	0	0 1/1 1/1 101009
81710	39350	357190	0	30090	128704	80590	1307	1644	1	1947	002	2 001	N	0	0 1/1 1/1 101009
64680	116640	0	0	0	0	58800	0	0	0	0	0	0	N	0	0 1/1 1/1 101009
114490	33750	80740	0	0	0	114490	2811	2811	4	1965	003 2	1 100	N	0	0 1/1 1/1 101009
230540	33750	221340	0	170670	512872	215470	2792	2792	4	1950	003 2	1 100	N	33750	37630 25% 25% 101009
348150	33750	282750	0	316500	789997	316500	2616	2616	5	1955	003 2	1 100	N	0	0 1/1 1/1 101009
29190	33750	0	0	26540	58052	26540	0	0	0	0	0	0	N	0	0 1/1 1/1 101009
297480	33750	263810	0	297560	720885	297560	2388	2388	4	1963	003 2	1 100	N	0	0 1/1 1/1 101009
260340	37120	239160	0	236680	519360	236680	1166	1166	1	1958	003 2	1 001	N	0	0 1/1 1/1 101009
309880	33760	276120	0	309880	743621	309880	2299	2299	4	1971	003 2	1 100	N	0	0 1/1 1/1 101009
1733690	481240	1253860	0	0	497105	1735100	6453	6453	0	1992	003 2	1 707	N	0	0 1/1 1/1 101009
3415990	1113750	2311650	0	3425400	7413914	3425400	62568	62568	0	1986	003 2	1 500	N	0	0 1/1 1/1 101027
1445540	899440	546330	0	1445770	3211327	1445770	11119	11119	0	1940	002 2	1 500	N	0	0 1/1 1/1 101009
315090	50630	264490	0	315120	770893	315120	2419	2419	4	1963	003 2	1 100	N	0	0 1/1 1/1 101009
207510	42190	251260	0	188650	584347	188650	2595	2595	3	1966	003 2	1 100	N	0	0 1/1 1/1 101009
189580	42190	250490	0	172350	564374	172350	2595	2595	3	1960	003 2	1 100	N	0	0 1/1 1/1 101009
75770	37130	180480	0	25000	119140	74730	1320	1380	1	2000	004 2	1 001	N	0	0 1/1 1/1 101009
81090	37130	154320	0	0	98492	79980	1320	1380	1	2000	004 2	1 001	N	0	0 1/1 1/1 101009
89510	55690	165490	0	38280	143813	88280	1320	1380	1	2000	004 2	1 001	N	0	0 1/1 1/1 101009
270850	33750	336870	0	0	0	246230	2972	2972	4	1965	003 2	1 100	N	0	0 1/1 1/1 101009
275930	33750	337290	0	250850	712892	250850	2972	2972	4	1965	003 2	1 100	N	0	0 1/1 1/1 101009
232100	33750	247840	0	211000	607103	211000	2236	2236	4	1957	003 2	1 100	N	0	0 1/1 1/1 101009
331440	33750	331600	0	301310	769462	301310	2808	2808	4	1964	003 2	1 100	N	0	0 1/1 1/1 101009

L_DATE	B_DATE	S/S/S/S/D	DISAS	SEN_EX_CO	SEN_EX_CIT	PI	POR	PORTED_VA	PI	PORT_PMA	PORT_PSO	PO	PORT_PFO	PORT	PORT_INTE	S/S/S/S/S/S/S/S	PRELIM_JU	PI
100506	100326			0	0	0	0	0	0	0	0				0		0	
100319	100426	Q		0	0	0	0	0	0	0	0				0		0	
100506	100601	T Q Q		0	0	0	0	0	0	0	0				0	I	0	
100319	100426	Q T T D		0	0	0	0	0	0	0	0				0		0	
60607	100531	D Q		0	0	0	0	0	0	0	0				0		0	
100513	100531	T		0	0	0	0	0	0	0	0				0		0	
100513	100531	E D		0	0	0	0	0	0	0	0				0	I	0	
100513	100531	Q T		0	0	0	0	0	0	0	0				0	I	0	
100513	100531	D		0	0	0	0	0	0	0	0				0		0	
100513	100531	Q		0	0	0	0	0	0	0	0				0		0	
100513	100713	Q		0	0	0	0	0	0	0	0				0		0	
100513	100531	T		0	0	0	0	0	0	0	0				0		0	
80624	90330	E D		0	0	0	0	0	0	0	0				0	I	0	
100528	100326	D		0	0	0	0	0	0	0	0				0		0	
100528	100326	Q D		0	0	0	0	0	0	0	0				0		0	
100520	100426	T Q		0	0	0	0	0	0	0	0				0		0	
100922	100922	Q Q T		0	0	0	0	0	0	0	0				0		0	
100520	100525	Q Q Q Q		0	0	0	0	0	0	0	0				0		0	
100513	100531	Q		0	0	0	0	0	0	0	0				0		0	
100520	100426	Q Q D C		0	0	0	0	0	0	0	0				0		0	
100520	100426	Q T D		0	0	0	0	0	0	0	0				0		0	
100513	100531	Q D T		0	0	0	0	0	0	0	0				0		0	
70917	100531			0	0	0	0	0	0	0	0				0		0	
100528	100326			0	0	0	0	0	0	0	0				0		0	
100608	0 T			0	0	0	0	0	0	0	0				0		0	
100520	100426			0	0	0	0	0	0	0	0				0		0	
100520	100426	Q S		0	0	0	0	0	0	0	0				0		0	
100520	100426	E E E T		0	0	0	0	0	0	0	0				0		0	
100608	0 E E E T			0	0	0	0	0	0	0	0				0		0	
100520	100426	T Q T C		0	0	0	0	0	0	0	0				0		0	
100528	100326	Q T E T		0	0	0	0	0	0	0	0				0		0	
100520	100426	T Q Q D		0	0	0	0	0	0	0	0				0		0	
81217	90330			0	0	0	0	0	0	0	0				0		0	
100513	100531			0	0	0	0	0	0	0	0				0		0	
70519	100531	D T		0	0	0	0	0	0	0	0				0		0	
100520	100426	T Q		0	0	0	0	0	0	0	0				0		0	
100520	100426	E C T		0	0	0	0	0	0	0	0				0		0	
100520	100426	E T		0	0	0	0	0	0	0	0				0		0	
100528	100326			0	0	0	0	0	0	0	0				0		0	
100528	100326	D	0 Y	33520	33520	0	0	0	0	0	0				0	I	0	
100528	100326			0	0	0	0	0	0	0	0				0		0	
100520	100426			0	0	0	0	0	0	0	0				0		0	
100520	100426	S D		0	0	0	0	0	0	0	0				0		0	
100520	100525	Q Q Q Q		0	0	0	0	0	0	0	0				0		0	
100520	100426	T Q		0	0	0	0	0	0	0	0				0		0	

GIS_SQUAR	ACTU	LAST_OV	CENSUS_BLO	SAI	SAI	SAI	SAI	SAI	PAIFLAI	MI	MISC_DIST	NCU_LAND	NCU_BLDG	BEDS	BATH	LY_NCU_LA	LY_NCU_BL	LY_SB_SOH	CBROW	LYCBROW	GRANNY_FL
6750	0821	FL	120110417003						D40	21	0	0	0	0.0	0.0	0	0	87750	0	0	0
10125	1963	0120	120110417003	01					F09	59	0	0	0	4.0	4.0	0	0	317170	0	0	0
6750	1953	0821	120110417003	11	01	02			D40	22	0	0	0	2.0	1.0	0	0	51230	0	0	0
6750	1976	0120	120110417003	01	11	11	30	12	F09	58	0	0	0	0.0	0.0	0	0	224630	0	0	0
76801	1982	0820	120110417003	40						59	0	0	0	0.0	0.0	0	0	3951000	0	0	0
23625	1974	0120	120110415001	11						58	0	0	0	0.0	0.0	0	0	1035710	0	0	0
20251	1945	0120	120110415001	05	05					58	0	0	0	0.0	0.0	0	0	1063530	0	0	0
60749	1973	0122	120110415001	01	11					58	0	0	0	0.0	0.0	0	0	3221110	0	0	0
6750	1956	0120	120110415001	40						58	0	0	0	0.0	0.0	0	0	583390	0	0	0
11813	1957	0120	120110415001	01						59	0	0	0	0.0	0.0	0	0	1082170	0	0	0
21938	1957	0120	120110415001	01						59	0	0	0	0.0	0.0	0	0	1349730	0	0	0
20250	1958	0120	120110415001	11						59	0	0	0	0.0	0.0	0	0	1044570	0	0	0
20250	1989	1220	120110415001	05	05					58	0	0	0	0.0	0.0	0	0	294920	0	0	0
10126	1953	1021	120110417003	18					D40	22	0	0	0	2.0	1.0	0	0	263690	0	0	0
6750	1956	1021	FL 120110417003	01	11				D40	22	0	0	0	3.0	1.0	0	0	155680	0	0	0
10125	1957	0120	120110417003	11	01				F09	59	0	0	0	0.0	0.0	0	0	220920	0	0	0
6750	1954	0120	120110417003	01	01	11			F09	59	0	0	0	5.0	5.0	0	0	279450	0	0	0
6750	1962	0120	120110417003	01	01	01	01	02	F09	59	0	0	0	0.0	4.0	0	0	297700	0	0	0
45563	1983	0122	120110417003	01						59	0	0	0	0.0	0.0	0	0	1896700	0	0	0
10125	1120		120110417003	01	01	37	02	11	D40	21	0	0	0	0.0	0.0	0	0	131630	0	0	0
10125	1220		120110417003	01	11	11				58	0	0	0	0.0	2.0	0	0	182250	0	0	0
28687	1952	0222	120110417003	01	40	11				58	0	0	0	0.0	0.0	0	0	1023540	0	0	0
13500	1973	0120	120110417003							59	0	0	0	20.0	10.0	0	0	766540	0	0	0
7155	1946	1021	FL 120110417003						D40	21	0	0	0	2.0	1.0	0	0	81710	0	0	0
9720	0120		120110417003	11						21	0	0	0	0.0	0.0	0	0	126360	0	0	0
6750	1964	0120	120110417003						F09	59	0	0	0	4.0	4.0	0	0	114490	0	0	0
6750	1949	0120	120110417003	01	02				F09	59	0	0	176280	0.0	0.0	0	160250	248730	0	0	0
6750	1954	0120	120110417003	05	05	03	11	11	F09	59	0	0	0	0.0	0.0	0	0	373680	0	0	0
3375	1021		120110417003	05	05	03	11	11	D40	21	0	0	0	0.0	0.0	0	0	43880	0	0	0
6750	1962	0120	120110417003	11	01	11	02	12	F09	59	0	0	0	0.0	4.0	0	0	297480	0	0	0
6749	1955	1021	120110417003	01	11	01	11	30	D40	21	0	0	0	3.0	2.0	0	0	281070	0	0	0
6751	1970	0120	120110417003	11	01	01	40	30	F09	58	0	0	0	4.0	4.0	0	0	309880	0	0	0
91664	1991	0120	120110417003							58	0	0	0	0.0	4.0	0	0	1733690	0	0	0
111375	1985	0120	120110417003							58	0	0	0	0.0	10.0	0	0	3415990	0	0	0
87750	1965	0120	120110415001	30	11					58	0	0	0	0.0	0.0	0	0	1445540	0	0	0
10125	1962	0120	120110417003	11	01				F09	59	0	0	0	0.0	4.0	0	0	315090	0	0	0
8437	1959	0120	120110417003	01	02	11			F09	59	0	0	0	0.0	0.0	0	0	315120	0	0	0
8438	1959	0120	120110417003	01	11				F09	59	0	0	0	0.0	0.0	0	0	306280	0	0	0
6750	1999	1021	FL 120110417003						D44	21	0	0	0	2.0	2.0	0	0	75770	0	0	0
6750	1999	1021	FL 120110417003						D44	21	0	0	0	3.0	2.0	0	0	81090	0	0	0
10125	1999	1021	FL 120110417003						D44	21	0	0	0	2.0	2.0	0	0	89510	0	0	0
6750	1964	0120	120110417003						F09	59	0	0	0	8.0	4.0	0	0	370880	0	0	0
6750	1964	0120	120110417003	02	37				F09	59	0	0	0	8.0	4.0	0	0	371740	0	0	0
6750	1956	0120	120110417003	01	01	01	01	12	F09	59	0	0	0	4.0	4.0	0	0	281640	0	0	0
6750	1963	0120	120110417003	11	01				F09	59	0	0	0	0.0	0.0	0	0	366030	0	0	0

CRA	DAMA	STORM_ASSF	CLEANCLEAN_ASSE	EXICOMB_SPI	GRANNY_F_V	BI	SALE1_CIN	SALE2_CIN	SALE3_CIN	SALE4_CIN	SALES_CIN
03002		F3	6750.00	0.00		0 0 0	0.0000000000	0.0000000000	0.0000000000	0.0000000000	0.0000000000
03002		F2	10125.00	0.00		0 0 0	#####	0.0000000000	0.0000000000	0.0000000000	0.0000000000
03002		F1	1.00	0.00		0 0 0	0.0000000000	0.0000000000	0.0000000000	0.0000000000	0.0000000000
03002		F1	2.00	0.00		0 0 0	#####	#####	#####	#####	#####
03002		F2	76801.00	0.00		0 0 0	#####	0.0000000000	0.0000000000	0.0000000000	0.0000000000
03002		F2	23625.00	0.00		0 0 0	#####	0.0000000000	0.0000000000	0.0000000000	0.0000000000
03002		F2	20251.00	0.00		0 0 0	#####	0.0000000000	0.0000000000	0.0000000000	0.0000000000
03002	REMD	F2	60749.00	0.00		0 0 0	#####	0.0000000000	0.0000000000	0.0000000000	0.0000000000
03002		F2	6750.00	0.00		0 0 0	#####	0.0000000000	0.0000000000	0.0000000000	0.0000000000
03002		F2	11813.00	0.00		0 0 0	#####	0.0000000000	0.0000000000	0.0000000000	0.0000000000
03002		F2	21938.00	0.00		0 0 0	#####	0.0000000000	0.0000000000	0.0000000000	0.0000000000
03002		F2	20250.00	0.00		0 0 0	0.0000000000	0.0000000000	0.0000000000	0.0000000000	0.0000000000
03002		F2	20250.00	0.00		0 0 0	#####	0.0000000000	0.0000000000	0.0000000000	0.0000000000
03002		F1	1.00	0.00		0 0 0	#####	0.0000000000	0.0000000000	0.0000000000	0.0000000000
03002		F1	1.00	0.00		0 0 0	#####	#####	0.0000000000	0.0000000000	0.0000000000
03002		F1	2.00	0.00		0 0 0	#####	#####	0.0000000000	0.0000000000	0.0000000000
03002		F2	6750.00	0.00		0 0 0	#####	#####	0.0000000000	0.0000000000	0.0000000000
03002		F2	6750.00	0.00		0 0 0	#####	#####	#####	0.0000000000	0.0000000000
03002	REMD	F2	45563.00	0.00		0 0 0	#####	0.0000000000	0.0000000000	0.0000000000	0.0000000000
03002		F3	10125.00	0.00		0 0 0	#####	#####	#####	0.0000000000	0.0000000000
03002		F3	10125.00	0.00		0 0 0	#####	#####	#####	0.0000000000	0.0000000000
03002		F2	28687.00	0.00		0 0 0	#####	#####	#####	0.0000000000	0.0000000000
03002		F2	13500.00	0.00		0 0 0	0.0000000000	0.0000000000	0.0000000000	0.0000000000	0.0000000000
03002		F1	1.00	0.00		0 1 0	0.0000000000	0.0000000000	0.0000000000	0.0000000000	0.0000000000
03002			0.00	0.00		0 0 0	#####	0.0000000000	0.0000000000	0.0000000000	0.0000000000
03002			0.00	0.00		0 0 0	0.0000000000	0.0000000000	0.0000000000	0.0000000000	0.0000000000
03002		F2	6750.00	0.00		0 0 0	#####	#####	0.0000000000	0.0000000000	0.0000000000
03002		F2	6750.00	0.00		0 0 0	#####	0.0000000000	0.0000000000	0.0000000000	0.0000000000
03002		F3	3375.00	0.00		0 0 0	#####	0.0000000000	0.0000000000	0.0000000000	0.0000000000
03002		F2	6750.00	0.00		0 0 0	#####	#####	#####	0.0000000000	0.0000000000
03002		F1	1.00	0.00		0 0 0	#####	#####	#####	0.0000000000	0.0000000000
03002		F2	6751.00	0.00		0 0 0	#####	#####	#####	0.0000000000	0.0000000000
03002		F2	91664.00	0.00		0 0 0	0.0000000000	0.0000000000	0.0000000000	0.0000000000	0.0000000000
03002		F2	111375.00	0.00		0 0 0	0.0000000000	0.0000000000	0.0000000000	0.0000000000	0.0000000000
03002		F2	87750.00	0.00		0 0 0	#####	0.0000000000	0.0000000000	0.0000000000	0.0000000000
03002		F2	10125.00	0.00		0 0 0	#####	#####	0.0000000000	0.0000000000	0.0000000000
03002		F1	3.00	0.00		0 0 0	#####	0.0000000000	0.0000000000	0.0000000000	0.0000000000
03002		F1	3.00	0.00		0 0 0	0.0000000000	0.0000000000	0.0000000000	0.0000000000	0.0000000000
03002		F1	1.00	0.00		0 0 0	0.0000000000	0.0000000000	0.0000000000	0.0000000000	0.0000000000
03002		F1	1.00	0.00		0 0 0	0.0000000000	0.0000000000	0.0000000000	0.0000000000	0.0000000000
03002		F1	1.00	0.00		0 0 0	0.0000000000	0.0000000000	0.0000000000	0.0000000000	0.0000000000
03002			0.00	0.00		0 0 0	0.0000000000	0.0000000000	0.0000000000	0.0000000000	0.0000000000
03002		F2	6750.00	0.00		0 0 0	#####	0.0000000000	0.0000000000	0.0000000000	0.0000000000
03002		F2	6750.00	0.00		0 0 0	#####	#####	0.0000000000	0.0000000000	0.0000000000
03002		F2	6750.00	0.00		0 0 0	#####	#####	0.0000000000	0.0000000000	0.0000000000

S/A	AFF	COUNTY_AI	SCHOOL_AI	CITY_AH_AI	INDEP_AH_TI	POR	BLDG_UNDER	HE3_AMOU	SCHOOL_EX	ESRI_OID
		0	0	0	0		0	0	0	337
		0	0	0	0		0	0	0	338
		0	0	0	0		729	0	0	339
D		0	0	0	0		0	0	0	340
		0	0	0	0		0	0	0	341
		0	0	0	0		0	0	0	342
		0	0	0	0		0	0	0	343
		0	0	0	0		0	0	0	336
		0	0	0	0		0	0	0	344
		0	0	0	0		0	0	0	345
		0	0	0	0		0	0	0	346
		0	0	0	0		0	0	0	347
		0	0	0	0		0	0	0	348
		0	0	0	0		784	0	0	349
		0	0	0	0		960	0	0	350
		0	0	0	0		0	0	0	351
		0	0	0	0		0	0	0	352
Q		0	0	0	0		0	0	0	353
		0	0	0	0		0	0	0	335
T		0	0	0	0		0	0	0	354
		0	0	0	0		0	0	0	355
		0	0	0	0		0	0	0	356
		0	0	0	0		0	0	0	357
		0	0	0	0		1070	0	0	358
		0	0	0	0		0	0	0	359
		0	0	0	0		0	0	0	360
		0	0	0	0		0	0	0	361
T		0	0	0	0		0	0	0	362
T		0	0	0	0		0	0	0	363
D		0	0	0	0		0	0	0	364
D		0	0	0	0		1166	0	0	365
D		0	0	0	0		0	0	0	366
		0	0	0	0		0	0	0	367
		0	0	0	0		0	0	0	368
		0	0	0	0		0	0	0	369
		0	0	0	0		0	0	0	370
		0	0	0	0		0	0	0	371
		0	0	0	0		0	0	0	372
		0	0	0	0		1290	0	0	373
		0	0	0	0		1290	0	0	374
		0	0	0	0		1290	0	0	375
		0	0	0	0		0	0	0	376
		0	0	0	0		0	0	0	377
D		0	0	0	0		0	0	0	378
		0	0	0	0		0	0	0	379

BINDING EDGE

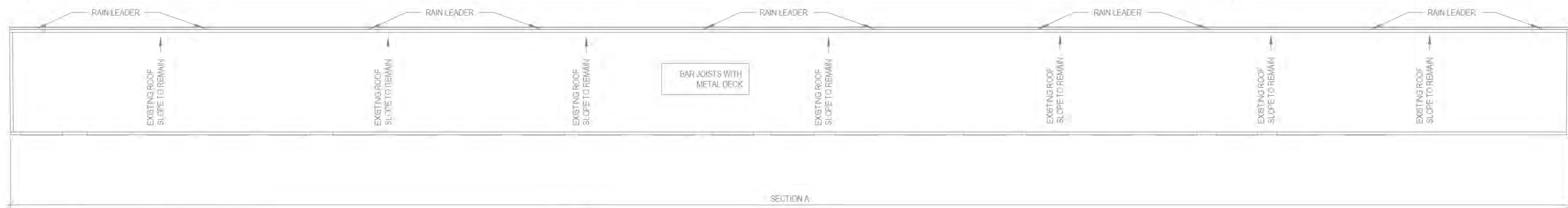

3 BUILDING A ROOF PLAN KEY
1/16" = 1'-0"

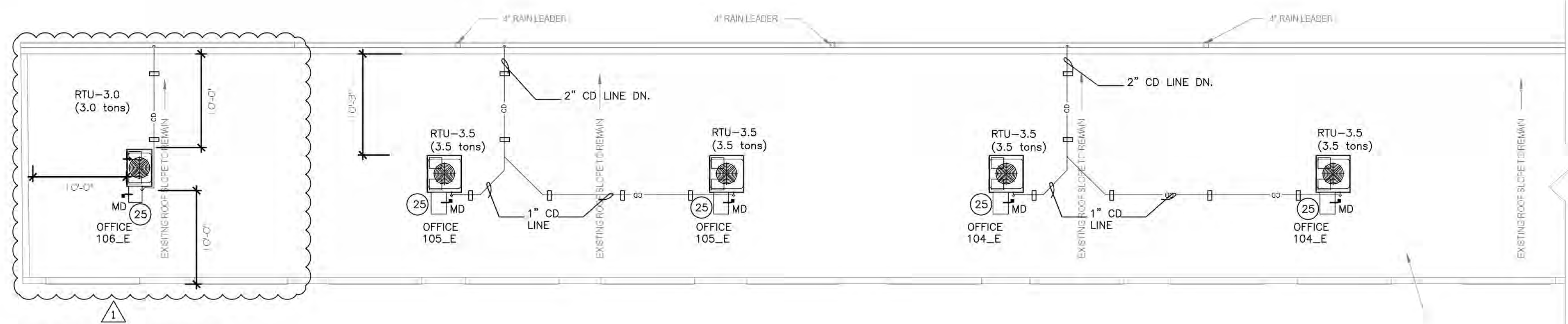

2 BUILDING A ROOF PLAN - SECTION B
1/8" = 1'-0"

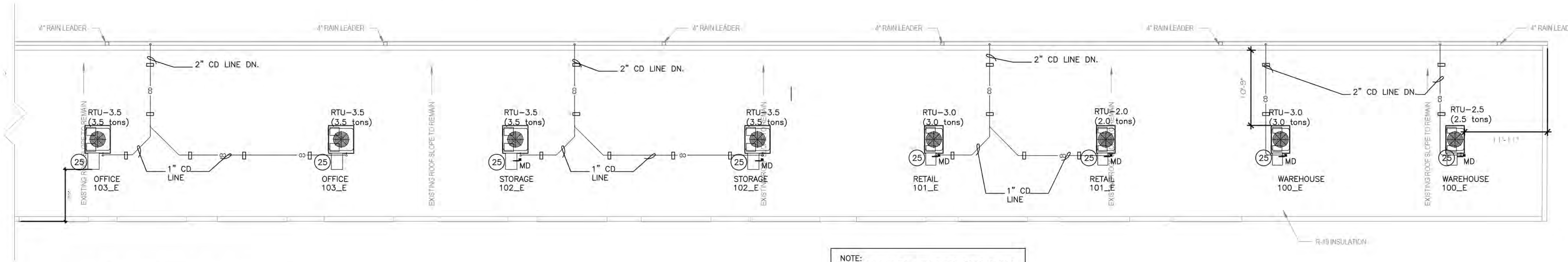

1 BUILDING A ROOF PLAN - SECTION A
1/8" = 1'-0"

NOTE:
THE EQUIPMENTS WITH THEIR ROOF CURBS
MUST BE INSTALLED WHERE THE DUCTWORKS
ARE LOCATED BETWEEN THE JOIST.
(TYPICAL FOR ALL BUILDINGS)

KEY NOTES HVAC

- 1 FULL SIZE SUPPLY / RETURN AIR PLENUM.
- 2 PROGRAMMABLE THERMOSTAT MOUNTED TO 48" A.F.F. TEMPERATURE SENSORS AS PER PLANS TO OPERATE ON AVERAGE TEMPERATURE. TEMPERATURE SENSOR AT RETURN DUCT OR INSIDE OF A/C CLOSET.
- 3 (VERTICAL) UPFLOW AIR HANDLER UNIT (AHU) AS SIZED ON PLAN. PROVIDE MINIMUM 6" SERVICE / MAINTENANCE AREA AROUND AIR HANDLING UNIT.
- 4 CONDENSER UNIT ON STAND SUPPORT. TIE DOWN SHALL BE MIAMI-DADE APPROVED.
- 4A CONDENSER UNIT STAND SUPPORT FOR FUTURE USE.
- 4B REFRIGERANT LINES GOOSENECK FOR FUTURE USE. CAP THE OPENING.
- 5 1" DOOR UNDERCUT. TYPICAL.
- 6 CEILING EXHAUST FAN & GRILLE, AS SIZED ON PLAN W/BACKDRAFT DAMPER.
- 7 EXHAUST DUCT; AS SIZED ON PLAN GOING TO WALL CAP OR ROOF CAP. WALL CAP WITH CORROSION RESISTANT SCREEN AND MUST BE MINIMUM 3FT. FROM ANY WINDOW.
- 8 HVAC DUCTWORK TO BE FIBER GLASS, INSTALLED AS PER SMACNA STANDARDS WITH 1.5" THICK (R-6) INSULATION FIRST FLOOR CEILING SPACE, 2.0" THICK (R-8) INSULATION WHEN RUNNING IN ATTIC SPACE, UNLESS NOTED OTHERWISE.
- 9 FLEXIBLE INSULATED DUCTWORK WITH 2" FIBERGLASS INSULATION WITH FRK VAPOR BARRIER, CLASS I AIR DUCT, U.L. R-8.0 INSULATION. LENGTH NO MORE OF 6 FT. TYPICAL.
- 10 PROVIDE FLEXIBLE DUCT CONNECTION WITH AHU & RTU.
- 11 REFRIGERANT PIPES AND CONDENSATE LINE RUNNING INSIDE CEILING SPACES
- 12 REFRIGERANT LINES AND CONDENSATE LINE FROM LEVEL ABOVE
- 13 REFRIGERANT SUCTION LINE TO BE INSULATED WITH INSULATION HAVING A THERMAL RESISTIVITY OF AT LEAST R-4 AND HAVING AN EXTERNAL PERMEANCE NOT EXCEEDING 0.05 PERM WHEN TESTED IN ACCORDANCE WITH ASTM E96. PROVIDE UV COAT PROTECTION.
- 14 REFRIGERANT CIRCUIT ACCESS PORTS LOCATED OUTDOORS SHALL BE FITTED WITH LOCKING-TYPE TAMPER-RESISTANT CAPS OR SHALL BE OTHERWISE SECURED TO PREVENT UNAUTHORIZED ACCESS UNLESS THE PORTS ARE LOCATED INSIDE THE CONDENSING UNIT CABINET (FBCR-1411.8)
- 15 CONDENSATE DRAIN LINE THROUGH THE WALL DOWN IN PARTITION WALL AND RUN UNDERGROUND.
- 16 PROVIDE MOTORIZED DAMPER (MD) FOR INTAKE O/A IN AHU. ELECTRICALLY INTERLOCK WITH A/C UNIT. MOTORIZED DAMPER TO BE LOW VOLTAGE.
- 17 CONDENSATE DRAIN LINE AND REFRIGERANT LINES THROUGH THE FLOOR DOWN IN PARTITION WALL TO CEILING SPACE OF 1ST FLOOR.
- 18 CONTRACTOR MUST VERIFY TOTAL REFRIGERANT PIPING LENGTH AND PIPING LIFT THAT IS NOT GREATER THAN THOSE VALUES RECOMMENDED BY MANUFACTURER. NOTIFY THE ENGINEER'S OFFICE WITH THIS SITUATION AND TO FIND THE BEST SOLUTION.
- 19 PROVIDE AUXILIARY CONDENSATE DRAIN PAN SEE AHU DETAIL.
- 20 SEE NOTE B
- 21 AC CLOSET AS A RETURN AIR PLENUM. NO COMBUSTIBLE MATERIAL INSIDE OF CLOSET.
- 22 PROVIDE AIR TEMPERATURE SENSOR TO R/A DUCT OR INSIDE A/C CLOSET OF THE AC SYSTEM. (FOR FUTURE)
- 23 PROVIDE RTU UNIT WITH CONVERTIBLE DUCT CONFIGURATION.
- 24 ROOF CURB MUST BE SET UP FOR UNIT BEING INSTALLED. ATTACH DUCTWORK TO CURB (FLANGES OF DUCT REST ON CURB) FOR FUTURE USE.
- 25 INTAKE AIR HOOD WITH FILTER AND MOTORIZED DAMPER CONTROL, WHICH WILL BE IN THE CLOSED POSITION DURING THE UNIT OFF CYCLE, OR IN HOURS OF UNOCCUPIED SPACES.
- 26 CONDENSATE DRAIN LINE RUNNING UNDERGROUND.
- 27 PROVIDE TO OUTDOOR AIR INTAKES AND EXHAUSTS WITH AUTOMATIC OR GRAVITY DAMPERS THAT CLOSE WHEN THE VENTILATION SYSTEM IS NOT OPERATING
- 28 DRY WELL FOR CONDENSATE LINES.

- NOTES:
- 1-MECHANICAL CONTRACTOR SHALL COORDINATE WITH ELECTRICAL CONTRACTOR DUCT LOCATION TO AVOID CONFLICTS WITH LIGHT FIXTURES. MINIMUM CLEAR CEILING SPACE TO RUN AC & LIGHTING SYSTEM SHALL BE PROVIDED DEPENDING ON THE LIGHT FIXTURE HOUSING.
 - 2-LOCATION OF ALL SUPPLY AIR AND RETURN AIR CEILING DEVICES SHALL BE COORDINATED WITH TRUSSES LOCATION TO AVOID CONFLICTS.
 - 3-MECHANICAL CONTRACTOR SHALL COORDINATE WITH GC CEILINGS PRIOR TO DUCTWORK ORDERING AND INSTALLATION.
 - 4-FINAL RUN OF CONDENSATE PIPES & TERMINATION SHALL BE COORDINATED WITH ARCHITECT.
 - 5-FINAL RUN OF REFRIGERANT LINES & FINAL LOCATION OF CONDENSER UNIT SHALL BE COORDINATED WITH ARCHITECT.
 - 6-CONDENSER UNIT SHOULD BE INSTALLED OBSERVING MANUFACTURER SERVICE CLEARANCES.
 - 7-CONDENSER UNIT SHOULD BE PLACED SO ROOF RUN-OFF WATER DOES NOT POUR DIRECTLY ON UNIT
 - 8-MECHANICAL CONTRACTOR SHALL COORDINATE NEW WALL CAP AND LOUVER LOCATION TO AVOID CONFLICTS WITH ELECTRICAL DEVICES AT EXTERIOR WALL, OBSERVING MINIMUM CLEARANCE REQUIRED BY ELECTRICAL CODE.
 - 9-CU MUST BE INSTALLED AT THE FFE OF THE HOUSE. ALL EQUIPMENT TO BE INSTALLED AT 9.0' NGVD.
 - 10-THE AC SYSTEM MUST BE TESTING AND BALANCE BY CERTIFY THIRD PART.

SCOPE OF WORK:
NEW AC SYSTEMS IN EXISTING BUILDING TO BE REMODEL.
NEW AIR DISTRIBUTION, NEW EXHAUST FAN AND DUCTWORK EXHAUST IN RESTROOM.

ENERGY CONSERVATION NOTES:
ALL HVAC EQUIPMENT SHALL BE EQUIPPED WITH PROGRAMMABLE THERMOSTAT TO ALLOW SYSTEM SHUT DOWN AFTER HOURS OF OPERATION. ALL LIGHTING HAS AFTER HOURS SHUT DOWN. ALL AC EQUIPMENT PROVIDE WITH OUTSIDE AIR MOTORIZED DAMPERS TO SHUT DOWN WHEN SPACE IS NOT USED.

ARCHITECT
MKDA FL
ARCHITECTURE + PLANNING + INTERIORS + BRANDING
2750 NW 3RD AVENUE, SPACE 6
MIAMI, FLORIDA 33127
AA26002738 ID26001526
MKDA FL, LLC © 2020
This drawing is the property of MKDA FL, LLC unless otherwise provided for by contract. The contents of this drawing are confidential and shall not be transmitted to any party except as authorized to by the Architect/ Engineer of Record.
CLIENT:
[THRIVE]
CONSULTANT:
Kimley Horn
Expect More. Experience Better.
CONSULTANT:
MCE
CONSULTANT:
arpe engineering inc
CONSULTANT:
IKOHN CONSULTANT

PERMIT SUBMITTAL
THRIVE DEVELOPMENT
701-745 NW 5TH AVENUE, FORT LAUDERDALE, 33311

REVISIONS		
Number	Description	Date
1	OWNER CHANGES/ RESPONSE TO COMMENTS	02/24/20

Date	12/11/2020
Scale	AS SHOWN
Drawn	AR
Checked	AR
Approved	APR

SEAL & SIGNATURE

PROJECT NAME: THRIVE DEVELOPMENT GROUP
PROJECT NUMBER: 9186-1
DESCRIPTION:

arpe engineering inc
2020 Ponce de Leon, Suite 1002
Coral Gables, Florida 33134
Phone > 305 444 9809
Fax > 305 444 9827
Engineering Design
> Mechanical > Electrical
> Plumbing > Fire Protection
www.arpe-eng.com

DATE: 2021.03.16 13:04:51
JOB # 30-0818
LICENSE # 60235
STATE OF FLORIDA
Professional Engineer Seal

MECHANICAL ROOF PLANS
BLDG. A
M-201

BINDING EDGE

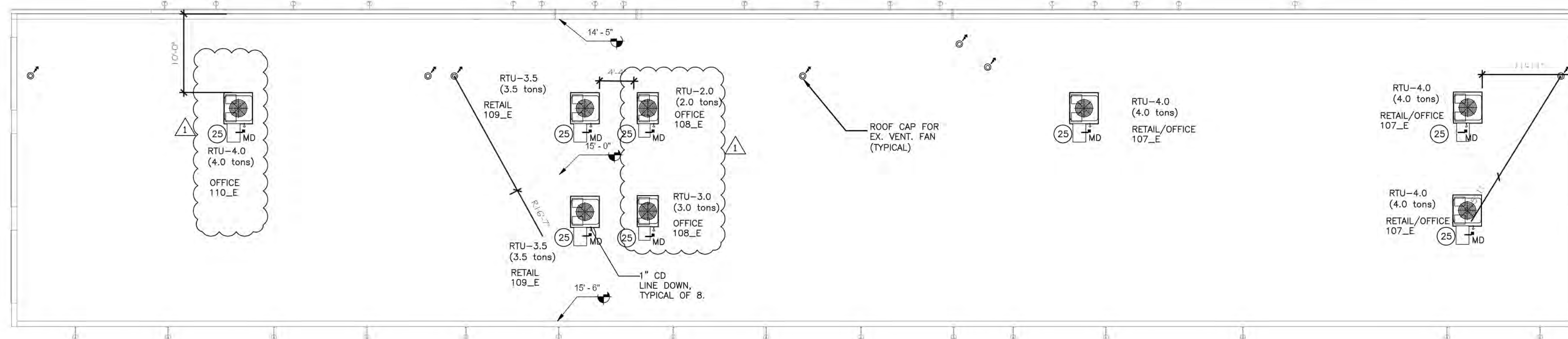

AS-BUILDING B ROOF PLAN.
1/8" = 1'-0"

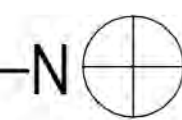

NOTE:
THE EQUIPMENTS WITH THEIR ROOF CURBS
MUST BE INSTALLED WHERE THE DUCTWORKS
ARE LOCATED BETWEEN THE JOIST.

ARCHITECT
MKDA FL
 ARCHITECTURE + PLANNING + INTERIORS + BRANDING
 2750 NW 3RD AVENUE, SPACE 6
 MIAMI, FLORIDA 33127
 AA28002738 ID28001526
 MKDA FL, LLC © 2020
 This drawing is the property of MKDA FL, LLC unless otherwise provided for by contract. The contents of this drawing are confidential and shall not be transmitted to any party except as authorized by the Architect/ Engineer of Record.

CLIENT
[THRIVE]

CONSULTANT:
Kimley Horn
 Expect More. Experience Better.

CONSULTANT:
MCE

CONSULTANT:
arpe engineering inc

CONSULTANT:
IKOHN CONSULTANT

PERMIT SUBMITTAL

THRIVE DEVELOPMENT
 701-745 NW 5TH AVENUE, FORT LAUDERDALE, 33311

REVISIONS		
Number	Description	Date
1	OWNER CHANGES/RESPONSE TO COMMENTS	02/24/20

Date	12/11/2020
Scale	AS SHOWN
Drawn	AR
Checked	AR
Approved	APR

SEAL & SIGNATURE

JORGE ALBERTO PERNAS, P.E.
 FL LICENSE NO. AR 92604

PROJECT NAME: THRIVE DEVELOPMENT GROUP

PROJECT NUMBER: 9186-1

DESCRIPTION:

Date: 2021.03.16 13:05:07 -04'00'

JOE # 20-0818
 R. # 20-0818
 License Number 60236
 No. 60236
 STATE OF FLORIDA
 PROFESSIONAL ENGINEER

arpe engineering inc
 2020 Ponce de Leon, Suite 1002
 Coral Gables, Florida 33134
 Phone > 305 444 9809
 Fax > 305 444 9827
 www.arpe-eng.com

MECHANICAL
 ROOF PLANS
 BLDG. B
 M-202

BINDING EDGE

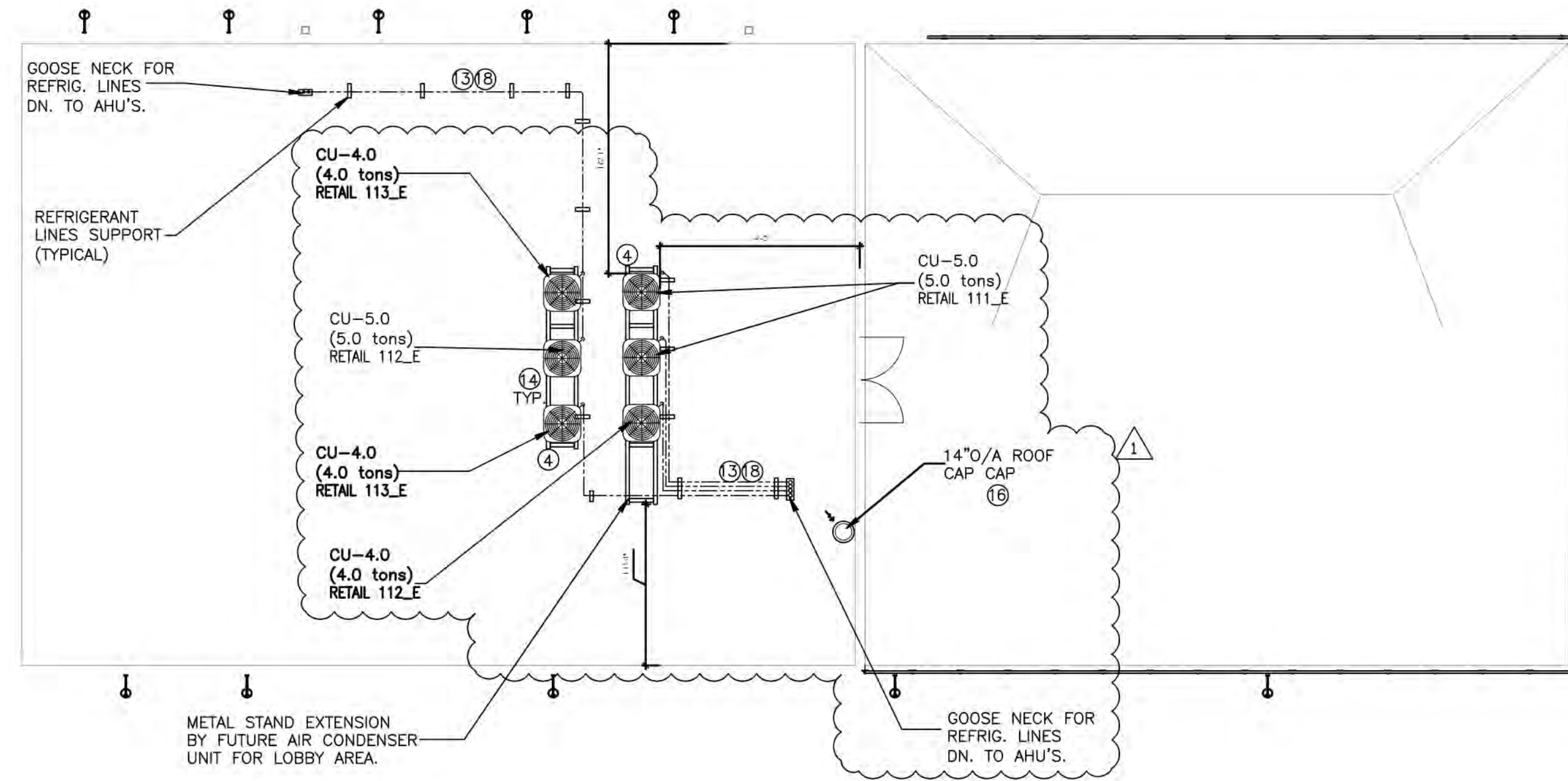

Ⓐ3 BUILDING C ROOF PLAN.
1/8" = 1'-0"



ARCHITECT
MKDA FL
 ARCHITECTURE + PLANNING + INTERIORS + BRANDING
 2750 NW 3RD AVENUE, SPACE 6
 MIAMI, FLORIDA 33127
 AA28002738 ID28001526
 MKDA FL, LLC © 2020
 This drawing is the property of MKDA FL, LLC unless otherwise provided for by contract. The contents of this drawing are confidential and shall not be transmitted to any party except as authorized by the Architect/ Engineer of Record.

CLIENT
[THRIVE]

CONSULTANT:
Kimley»Horn
 Expect More. Experience Better.

CONSULTANT:
MCE

CONSULTANT:
arpe engineering inc

CONSULTANT:
IKOHN CONSULTANT

PERMIT SUBMITTAL

THRIVE DEVELOPMENT
 701-745 NW 5TH AVENUE, FORT LAUDERDALE, 33311

REVISIONS		
Number	Description	Date
1	OWNER CHANGES/RESPONSE TO COMMENTS	02/24/20

Date	12/11/2020
Scale	AS SHOWN
Drawn	AR
Checked	AR
Approved	APR

SEAL & SIGNATURE

JORGE ALBERTO PERNAS, P.E.
 FL LICENSE NO. AR 92604

PROJECT NAME: THRIVE DEVELOPMENT GROUP

PROJECT NUMBER: 9186-1

DESCRIPTION:

MECHANICAL ROOF PLANS
BLDG. C
M-203

arpe engineering inc
 2020 Ponce de Leon, Suite 1002
 Coral Gables, Florida 33134
 Phone > 305 444 9909
 Fax > 305 444 9927
 Engineering Design:
 > Mechanical > Electrical
 > Plumbing > Fire Protection
 www.arpe-eng.com

Date: 2021.03.16
 13:05:18 -04'00'



BINDING EDGE

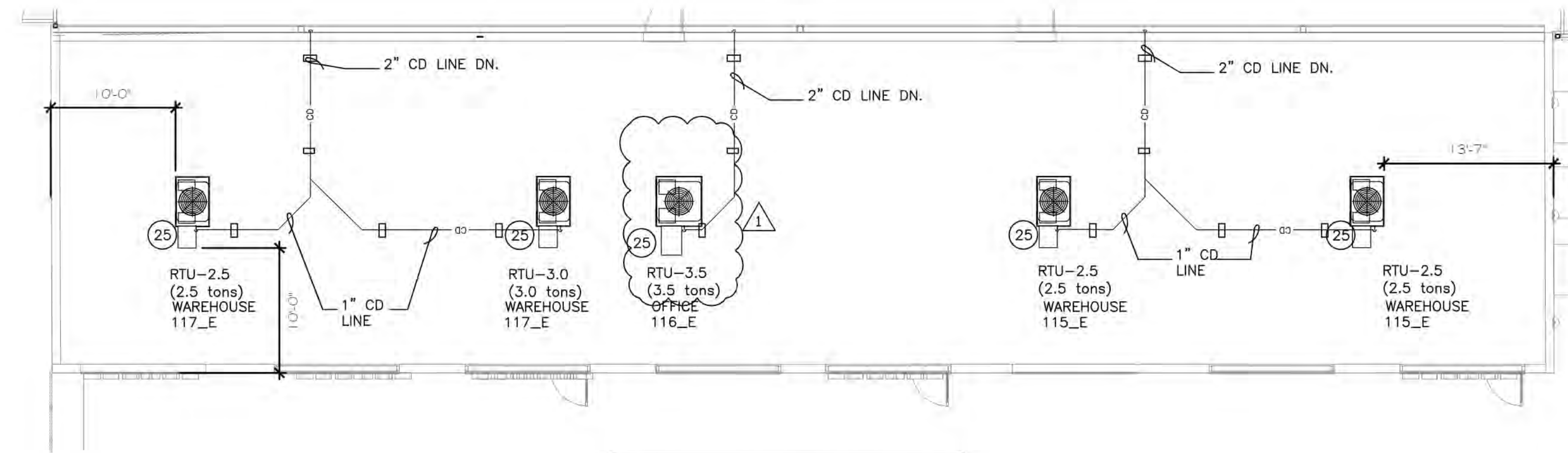

NOTE:
THE EQUIPMENTS WITH THEIR ROOF CURBS
MUST BE INSTALLED WHERE THE DUCTWORKS
ARE LOCATED BETWEEN THE JOIST.
(TYPICAL FOR ALL BUILDINGS)

① BUILDING D ROOF PLAN.
1/8" = 1'-0" N

ARCHITECT
MKDA FL
ARCHITECTURE + PLANNING + INTERIORS + BRANDING
2750 NW 3RD AVENUE, SPACE 6
MIAMI, FLORIDA 33127
AA28002738 ID28001526
MKDA FL, LLC © 2020
This drawing is the property of MKDA FL, LLC unless otherwise provided for by contract. The contents of this drawing are confidential and shall not be transmitted to any party except as authorized by the Architect/ Engineer of Record.

CLIENT
[THRIVE]

CONSULTANT:
Kimley»Horn
Expect More. Experience Better.

CONSULTANT:
MCE

CONSULTANT:
arpe engineering inc

CONSULTANT:
IKOHN CONSULTANT

PERMIT SUBMITTAL

THRIVE DEVELOPMENT
701-745 NW 5TH AVENUE, FORT LAUDERDALE, 33311

REVISIONS		
Number	Description	Date
1	OWNER CHANGES/ RESPONSE TO COMMENTS	02/24/20

Date	12/11/2020
Scale	AS SHOWN
Drawn	AR
Checked	AR
Approved	APR

SEAL & SIGNATURE



JORGE ALBERTO PERMAS, R.A.
FL LICENSE NO. AR 82604

PROJECT NAME: THRIVE DEVELOPMENT GROUP

PROJECT NUMBER: 9186-1

DESCRIPTION:

Date: 2021.03.16
13:05:29
-04'00"

arpe engineering inc
2020 Ponce de Leon, Suite 1002
Coral Gables, Florida 33134
Phone > 305 444 9809
Fax > 305 444 9827
www.arpe-eng.com

Engineering Design:
> Mechanical > Electrical
> Plumbing > Fire Protection

Professional Engineer
No. 60236
Lic. No. 16 60236
Rodriguez, P.E.

MECHANICAL
ROOF PLANS
BLDG. D
M-204

THRIVE EAST
710-726 NW 5 Avenue
Fort Lauderdale, FL 33311
Variance Request
Board of Adjustment



Table of Contents:

Page 1	Aerial
Page 2	Survey
Page 3	Approved DRC Site Plan
Page 4	Equipment Location Plan
Pages 5-8	Elevations
Page 9	Concept Renderings
Page 10	Concept Rooftop Render
Pages 11 & 12	Surrounding Properties

Jason Crush
Crush Law, P.A.
600 SE 2nd Court
Fort Lauderdale, FL 33311

954.522.2010
jcrush@crushlaw.com



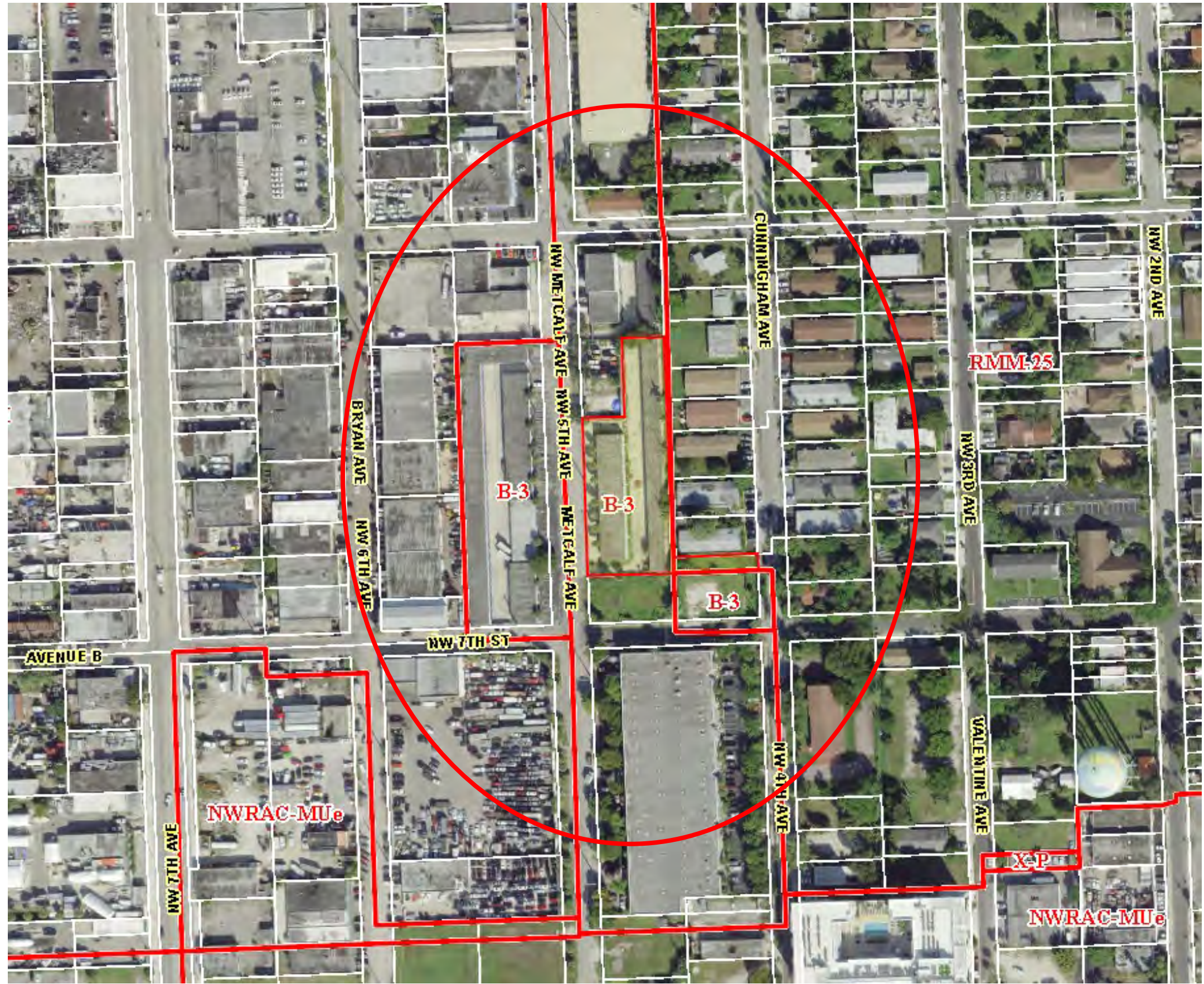

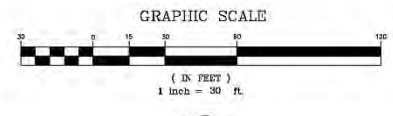

LEGEND

—●—	Overhead Wire Line	⊗	Existing Elevation
— — —	Wood Fence	⊙	Galch Bean
—x—x—	Chain Link Fence	⊖	Water Meter
— — —	Iron Fence	⊕	Electric Box
— — —	Monument Line	⊗	Sanitary Manhole
— — —	Property Line	⊗	Sprinkler Form
— — —		⊗	Wood Pole
— — —		⊗	Conc. Pole
— — —		⊗	Light Pole
— — —		⊗	Ft. Hydraz.
— — —		⊗	Water Valve
— — —		⊗	Het
— — —		⊗	Cable TV Box
— — —		⊗	Excav. Meter Box
— — —		⊗	Talk. Signal Box
— — —		⊗	Gas Valve
— — —		⊗	Monitoring Valve
— — —		⊗	Manhole

AC	— Air Conditioner
Conc.	— Concrete
C.B.S.	— Concrete Block & Stucco
D.E.	— Drainage Elevation
D.M.E.	— Drainage Maintenance Elevation
F.D.P.	— Found Drill Hole
F.F.Z.	— Fresh Floor Elevation
F.I.Z.	— Found Iron Pipe/Fit
F.I.R.	— Found Iron Rebar
F.L.	— Found Light
F.P.L.	— Found Power Line
H	— Height
L.M.C.	— Lake Maintenance Elevation
M	— Manhole
P	— Paved
P.O.D.	— Point of Beginning
P.O.C.	— Point of Commencement
R	— Record
Res.	— Residence
S.P.R.	— Sanitary Pipe/Recess
S	— Spread
V.E.	— Utility Elevation

THIS ITEM HAS BEEN ELECTRONICALLY SIGNED AND SEALED BY JACOB GOMIS, P.S.M. ON THE DATE ADJACENT TO THE SEAL USING A SHA AUTHENTICATION CODE.
 PRINTED COPIES OF THIS DOCUMENT ARE NOT CONSIDERED SIGNED AND SEALED AND THE SHA AUTHENTICATION CODE MUST BE VERIFIED ON ANY ELECTRONIC COPIES.

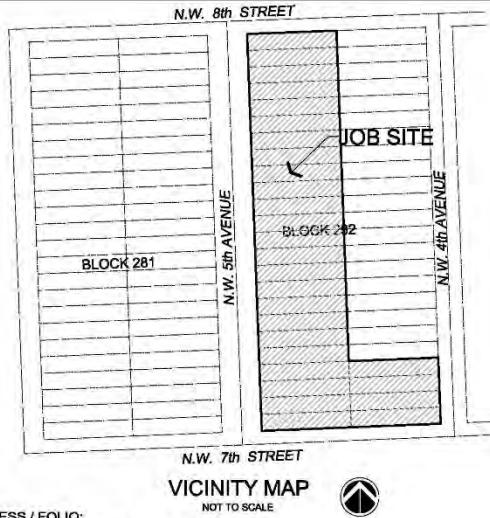

PROPERTY ADDRESS / FOLIO:
 744-748 NW 5 AVENUE, FORT LAUDERDALE, FLORIDA 33311 (FOLIO #4942-34-07-0250)
 710-726 NW 5 AVENUE, FORT LAUDERDALE, FLORIDA 33311 (FOLIO #4942-34-07-0100)
 413 415 NW 7 STREET, FORT LAUDERDALE, FLORIDA 33311 (FOLIO #4942 34 07 0120)
 405 NW 7 STREET, FORT LAUDERDALE, FLORIDA 33311 (FOLIO #4942-34-07-0110)

ZONING:
 CURRENT ZONING DESIGNATION: B-3 (Heavy Commercial/ Light Industrial Business)
 PROPOSED ZONING DESIGNATION: B-3 (Heavy Commercial/ Light Industrial Business)

LEGAL DESCRIPTION:
 PARCEL 5
 Lots 22, 23 and 24, Block 282, of "PROGRESSO", according to the Plat thereof, as recorded in Plat Book 2, Page 18, of the Public Records of Miami-Dade County, Florida; said lands now situate, lying and being in Broward County, Florida.

PARCEL 6
 Lots 25, 26, and 27, Block 282, of "PROGRESSO", according to the Plat thereof, as recorded in Plat Book 2, Page 18, of the Public Records of Miami-Dade County, Florida; said lands now situate, lying and being in Broward County, Florida.

PARCEL 7
 Lots 21, 28, 29, 30, 31, 32, 33, 34, 35, 36, 37 and the East 1/2 of Lots 38, 39, 40, 41 and 42, Block 282, of "PROGRESSO", according to the Plat thereof, as recorded in Plat Book 2, Page 18, of the Public Records of Miami-Dade County, Florida; said lands now situate, lying and being in Broward County, Florida.

PARCEL 8
 The West 1/2 of Lots 38, 39, 40, 41 and 42, and all of Lots 43, 44, 45, 46, 47 and 48, Block 282, of "PROGRESSO", according to the Plat thereof, as recorded in Plat Book 2, Page 18, of the Public Records of Miami-Dade County, Florida; said lands now situate, lying and being in Broward County, Florida.

- SURVEYOR'S NOTES:**
- The Legal Description to the Property was obtained from CHICAGO TITLE INSURANCE COMPANY, Commitment for Title Insurance.
 - This Certification is only for the lands as described; it is not a certification of Title, Zoning, Easements, or Freedom of Encumbrances. OPINION OF TITLE.
 - An examination of Commitment issued by CHICAGO TITLE INSURANCE COMPANY, Agent's File Number 5375442, effective date: July 23, 2015 @ 11:00 PM, was made to determine recorded instruments, if any affecting this property; however, there may be additional restrictions not shown on this survey that may be found in the Public Records of this County.
 - Accuracy: The Horizontal positional accuracy of well-defined improvement on this survey is 1/0.2'. The Vertical accuracy of elevations of well-defined improvement on this survey is 1/-0.1'. Foundations and/or footings that may cross beyond the boundary lines of the parcel herein described are not shown hereon.
 - Not valid without the signature and the original raised seal of a Florida Licensed Surveyor and Mapper. Additions or deletions to survey maps or reports by other than the signing party or parties are prohibited without written consent of the signing party or parties.
 - Contact the appropriate authority prior to any design work on the herein-described parcel for Building and Zoning information.
 - Underground utilities are not depicted hereon; contact the appropriate authority prior to any design work or construction on the property herein described. Surveyor shall be notified as to any deviation from utilities shown hereon.
 - The surveyor does not determine fence and/or well ownership.
 - Ownership is subject to OPINION OF TITLE.
 - Type of Survey: BOUNDARY SURVEY.
 - The North arrow shown hereon is based on record plat of "PROGRESSO", as recorded in Plat Book 2, at Page 18, of the Public Records of Dade County, Florida.
 - Zoning Information: B-3 (Heavy Commercial/Light Industrial District) Building Setbacks: Front & Street Side - 5 feet/ Rear & Side - 0 feet Information obtained from City of Fort Lauderdale Zoning Department.
 - All measurements shown hereon are made in accordance with the United States Standard Feet.
 - Flood Zone Data: Community/ Parcel #125105/0369/H. Dated: 08/18/2014. Flood Zone: "AH" Base Flood Elevation = +6'
 - Elevations shown hereon are relative to North American Vertical Datum of 1988
 - Benchmark Used: Broward County Benchmark
 - Subject Property has access to the following Public Right-of-Way: NW 7 Street and NW 5 Avenue
 - Total Area of Subject Property = 94,343 square feet (2.1658 +/- acres)
 - This SURVEY has been prepared for the exclusive use of the entities named hereon. The Certificate does not extend to any unnamed party.

SURVEYOR'S CERTIFICATE:
 I HEREBY CERTIFY:
 That this Survey meets the intent of the required Standards of Practice as set forth by the Florida Board of Professional Surveyors and Mappers in Chapter 5J-17, Florida Administrative Code, pursuant to Section 472.027, Florida Statutes.

Not valid without the signature and the original raised seal of a Florida Licensed Surveyor and Mapper. Additions or deletions to this survey by other than the signing party are prohibited without written consent of the signing party.

Jacob Gomis
 For the Firm Royal Point Land Surveyors, Inc. LB# 7282
 JACOB GOMIS, PROFESSIONAL SURVEYOR AND MAPPER, L#6231 STATE OF FLORIDA
 PABLO J. ALFONSO, PROFESSIONAL SURVEYOR AND MAPPER, L#5680 STATE OF FLORIDA

BOUNDARY SURVEY

FISH PROPERTY MANAGEMENT
 701-746 NW 5 AVENUE, FORT LAUDERDALE, FLORIDA

6175 NW 163rd STREET, SUITE 321, MIAMI LAKES, FL 33014 *** TEL: 305-822-0062 *** FAX: 305-827-9669
 info@royalpointls.com
 701-746 NW 5 AVENUE, FORT LAUDERDALE, FLORIDA

DRAWN: JG
 CHECKED: P.J.A.
 SCALE: 1" = 30'
 FIELD DATE: 11/12/2019
 JOB No.: RP19-1320
 SHEET:

1

Of 1 SHEET

BINDING EDGE

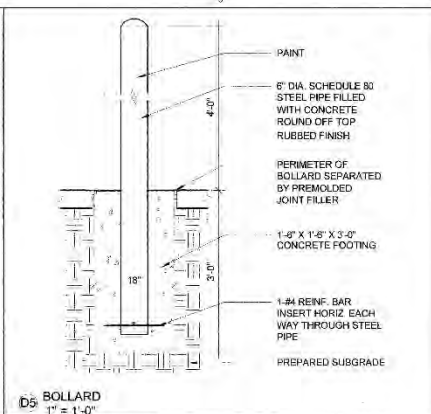

D5 BOLLARD
1" = 1'-0"

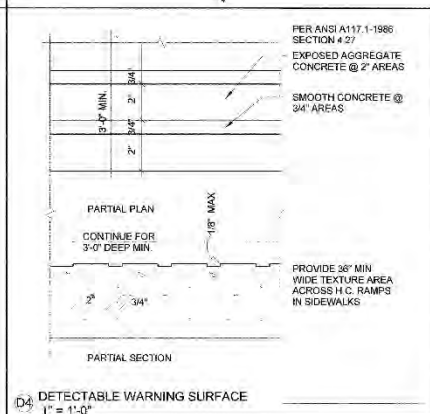

D4 DETECTABLE WARNING SURFACE
1" = 1'-0"

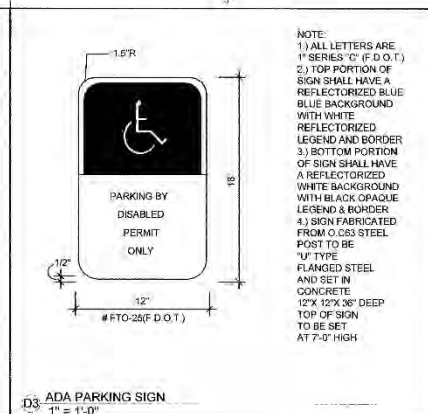

D3 ADA PARKING SIGN
1" = 1'-0"

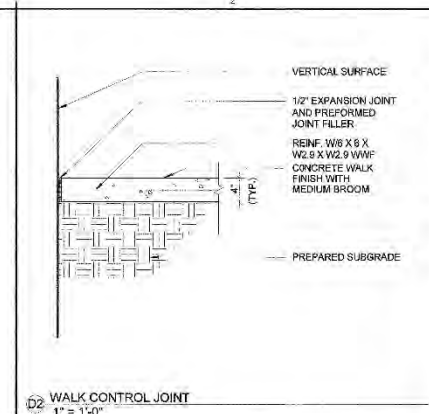

D2 WALK CONTROL JOINT
1" = 1'-0"

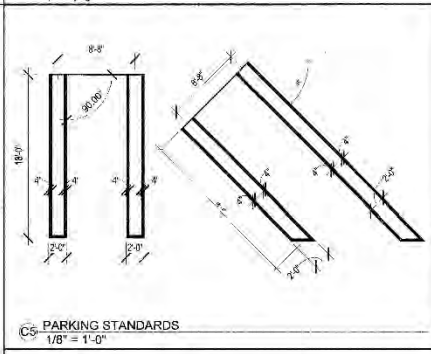

D6 PARKING STANDARDS
1/8" = 1'-0"

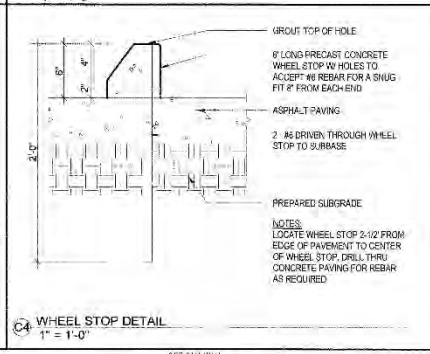

D4 WHEEL STOP DETAIL
1" = 1'-0"

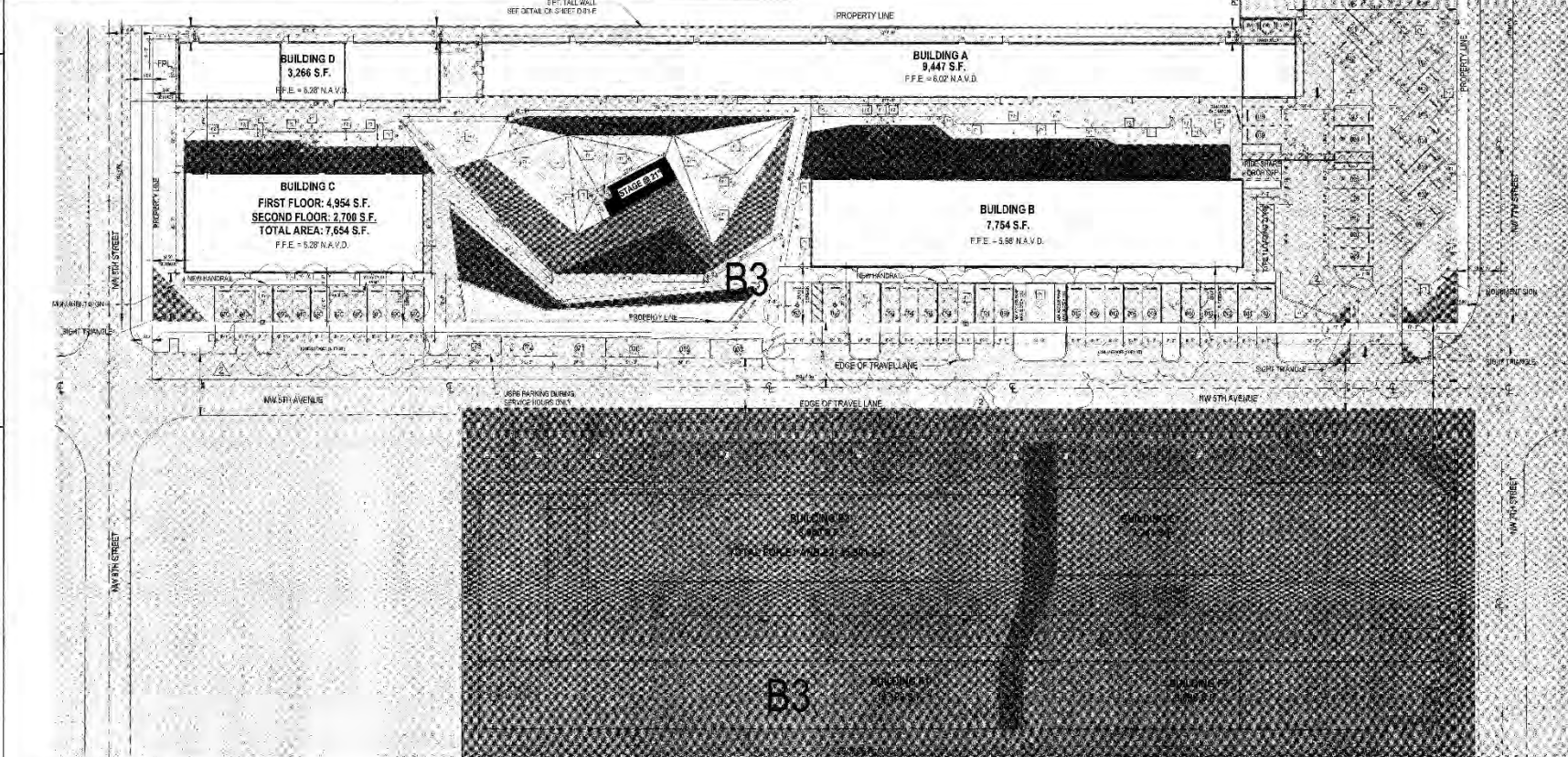
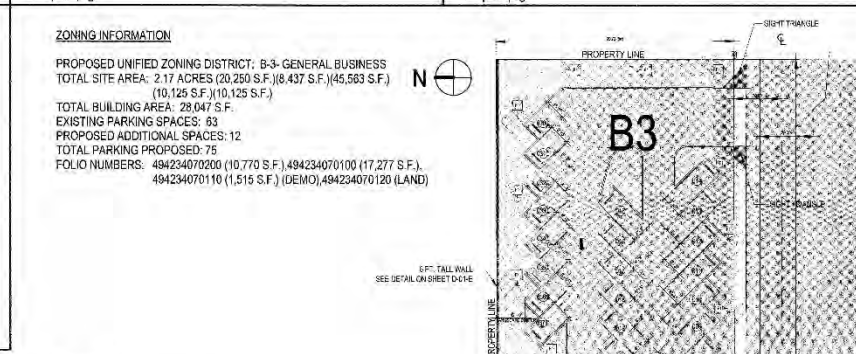

A5 PROPOSED SITE PLAN
1" = 30'-0"

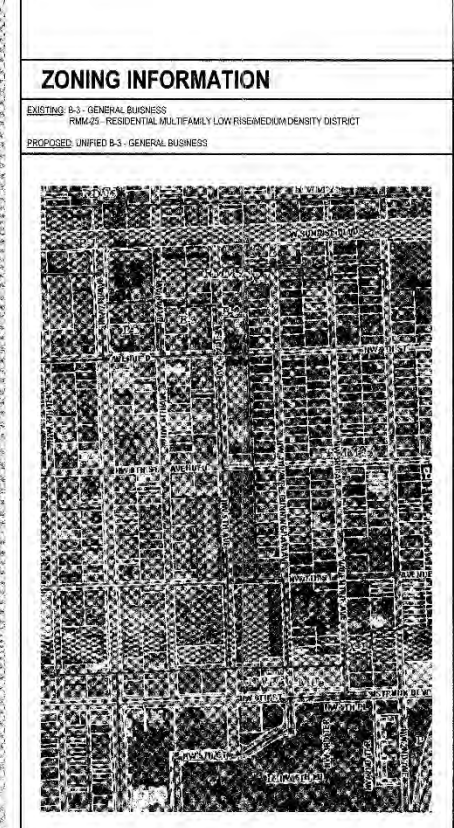
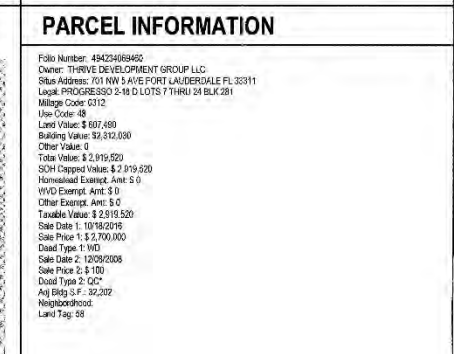
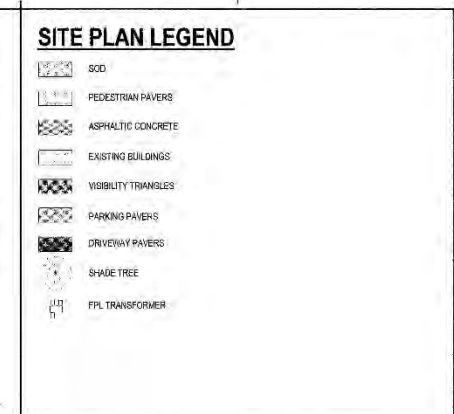

A1 LOCATION MAP - EAST
3/8" = 1'-0"

ARCHITECT:
 ARCHITECTURE + PLANNING + INTERIORS + BRANDING
 2750 NW 3RD AVENUE SPACE 8
 MIAMI, FL 33134
 A43092733 E2001953
 MIDA FL, LLC © 2020
 This drawing is the property of MIDA FL, LLC and is provided for your contract. The contents of this drawing are confidential and shall not be transmitted to any party except as authorized in writing by the Architect/Engineer of Record.
 CLIENT:

NATIONAL WATER RESTORATION

CONSULTANT:
Kimley Horn
 Experts Meet Experience Equals

CONSULTANT:

CONSULTANT:

DRC SUBMITTAL

THRIVE DEVELOPMENT
 701-748 NW 5TH AVENUE, FORT LAUDERDALE, 33311

Number	Description	Date
1	RESPONSE TO DRC COMMENTS 1	7/2/20
2	RESPONSE TO DRC COMMENTS 2	8/20/20

Date: 07/21/2020
 Scale: As Indicated
 Drawn: BP
 Check: JAP
 Approved: JAP

SEAL & SIGNATURE:

 JORGE ALBERTO PERRAS, P.E.
 FL LICENSE NO. AP 52594

PROJECT NAME: THRIVE DEVELOPMENT GROUP
 PROJECT NUMBER: 2020-01
 DESCRIPTION:

PROPOSED SITE PLAN EAST
C-01-E

BINDING EDGE

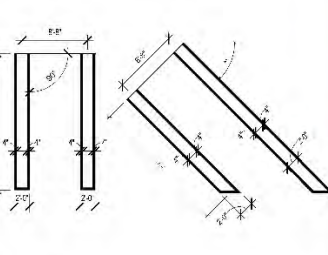
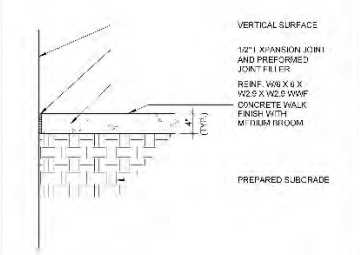
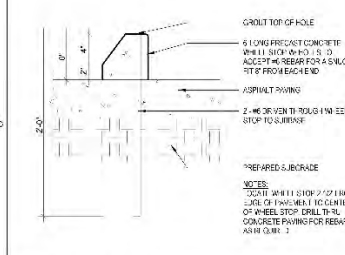

- SITE PLAN LEGEND**
- SOO
 - PEDESTAL PATHWAYS
 - AGGREGATE CONCRETE
 - EXISTING BUILDINGS
 - 4" GREN TY BRACKETS
 - 1/4" BUNGALOWS
 - SHADE TREE
 - PUL TRANSFORMER

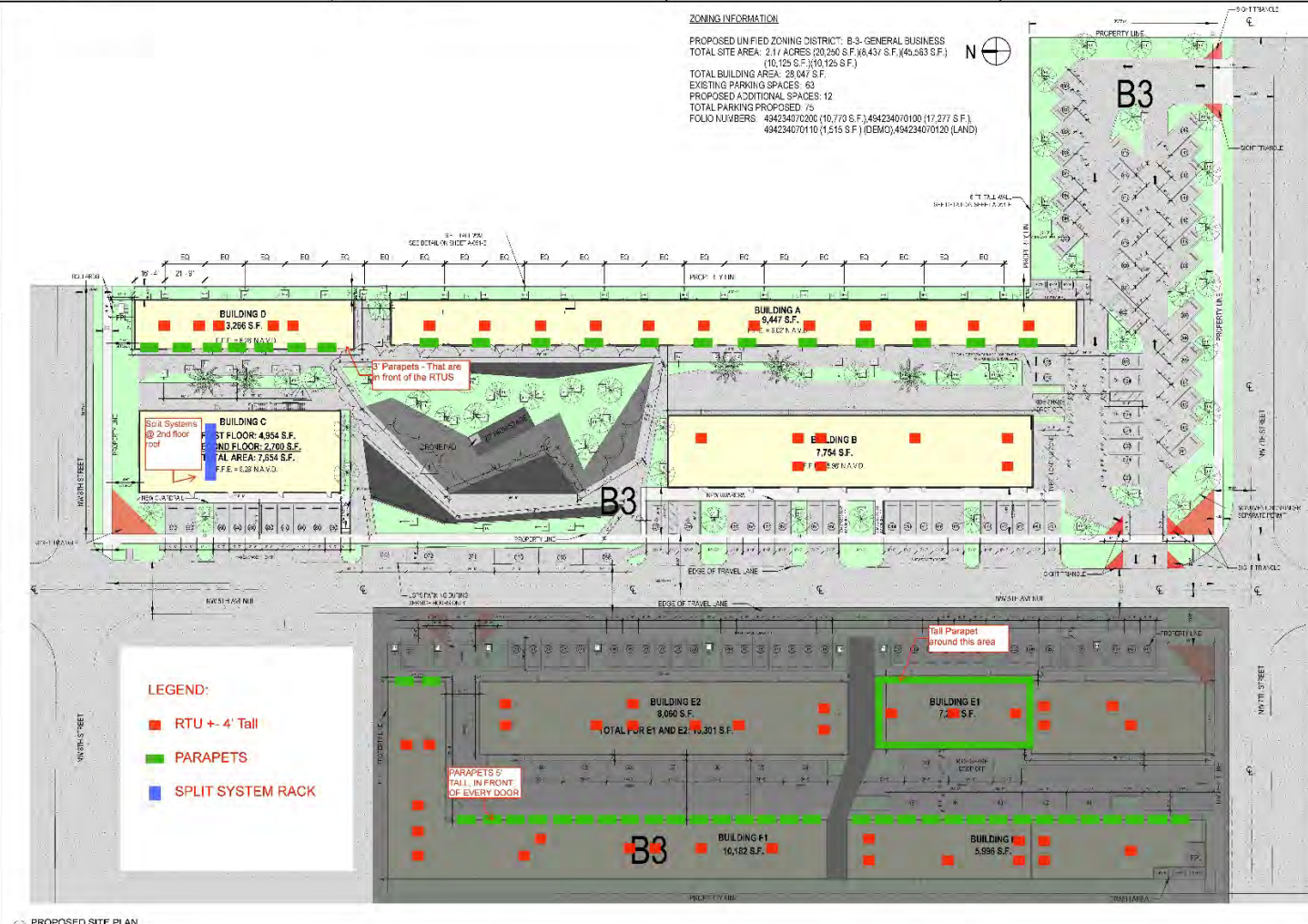
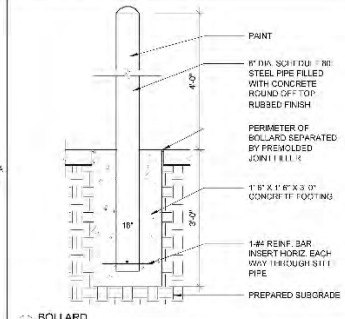
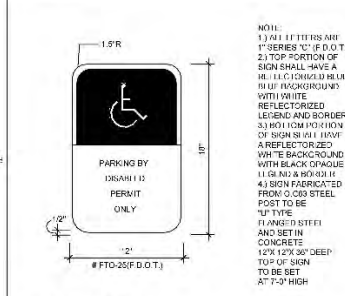
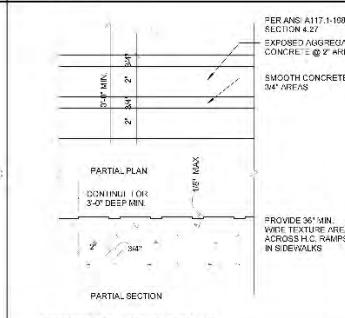

ARCHITECT
JMDA FL
ARCHITECTURE - PLANNING - INTERIOR DESIGN
230 NW 3RD AVENUE, SUITE 6
MIAMI, FL 33128
ARCHITECT: JMDA FL, LLC
MCA # 12, 0-200
The creation of the property of JMDA FL, LLC is a service provided for the client. The creation of this drawing is a service provided for the client. The client is responsible for the accuracy of the information provided to the architect and the architect is not responsible for the accuracy of the information provided to the client.

[THRIVE]

CONSULTANT
Kimley-Horn
Expert. Noted. Experienced. Better.

CONSULTANT
MCE

CONSULTANT
erpe engineering inc

CONSULTANT
IKOHN CONSULTANT

PERMIT SUBMITTAL

THRIVE DEVELOPMENT
701-745 NW 5TH AVENUE, FORT LAUDERDALE, 33311

NO.	REVISION	DATE
1	RESPONSE TO COMMENTS	3/1/2021

Scale: As shown
Date: 03/1/2021
Checked: JAP
Approved: JAP

Digitally signed by Jorge A. Permas
DN: c=US, o=JMDA FLORIDA, ou=ARCHITECT, email=jpermas@jmdafl.com, cn=Jorge A Permas
Date: 2021.03.02 12:05:09 -0500
JORGE ALBERTO PERMAS, R.A.
FL LICENSE NO. AR 12004

PROJECT NAME: THRIVE DEVELOPMENT CROFT
PROJECT NUMBER: 19881
DESCRIPTION: 19881

SITE PLAN
A-050E

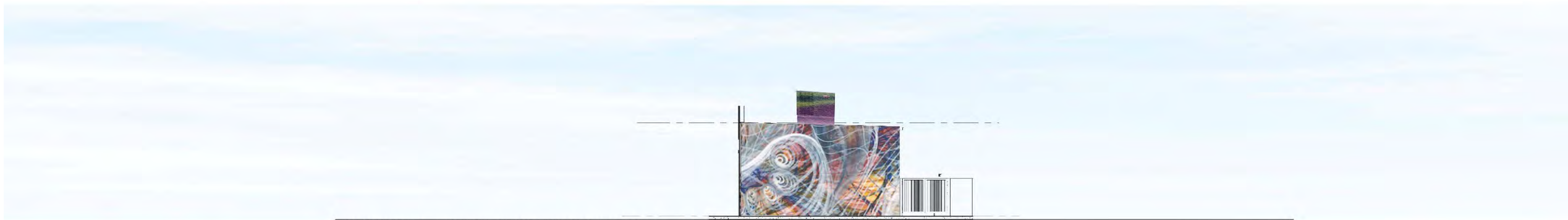

BUILDING A - SOUTH FACADE (BY PARKING LOT)

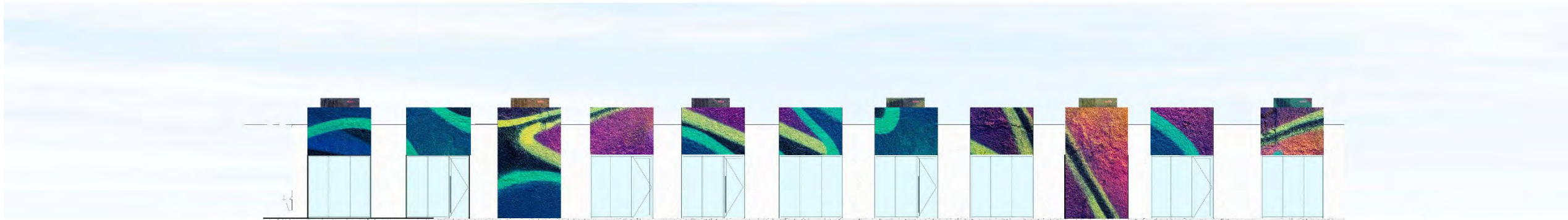

BUILDING A - WEST FACADE (PART A)

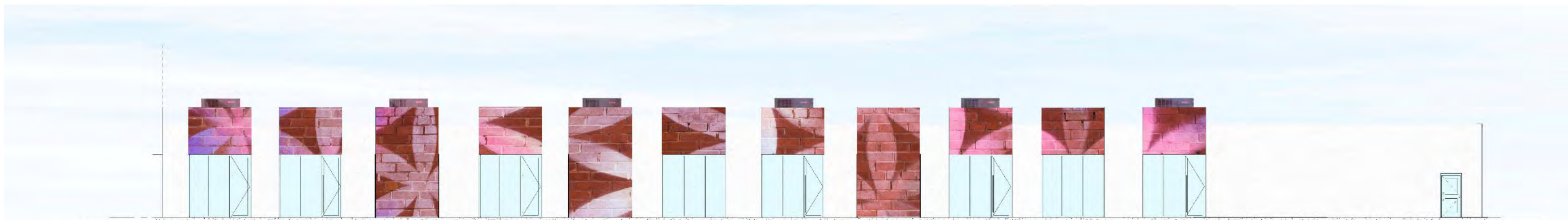

BUILDING A - WEST FACADE (PART B)

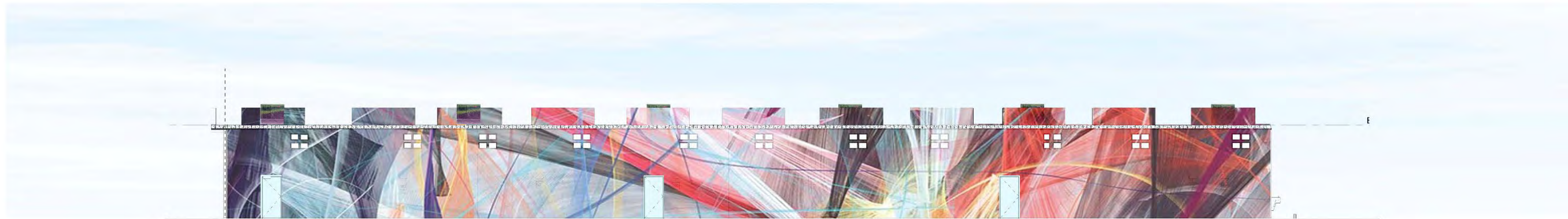

BUILDING A (East Facade)

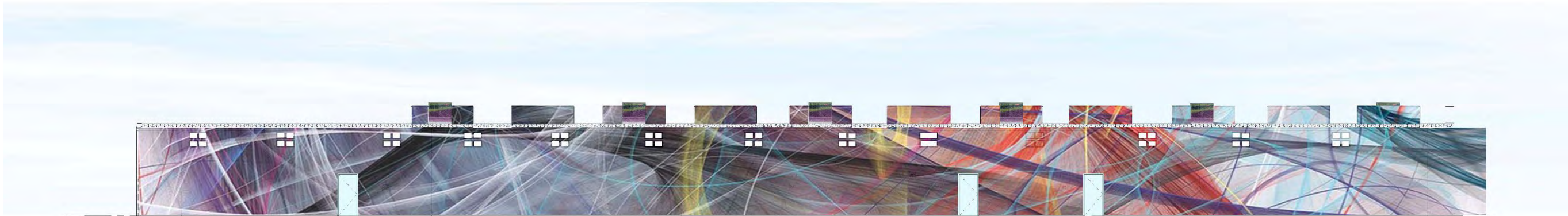

BUILDING A (East Facade)



BUILDING B - NORTH FACADE

BUILDING B - SOUTH FACADE

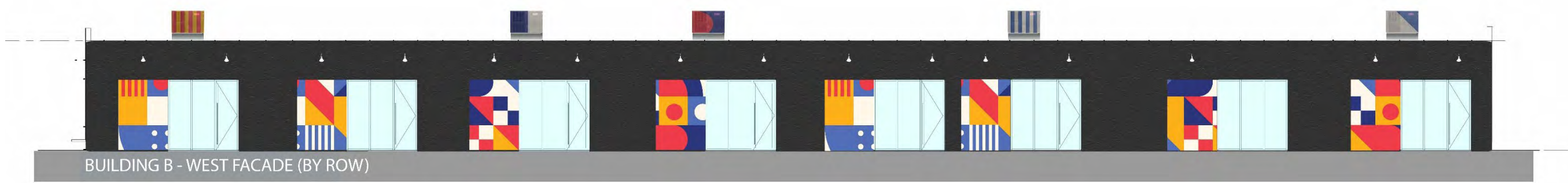

BUILDING B - WEST FACADE (BY ROW)

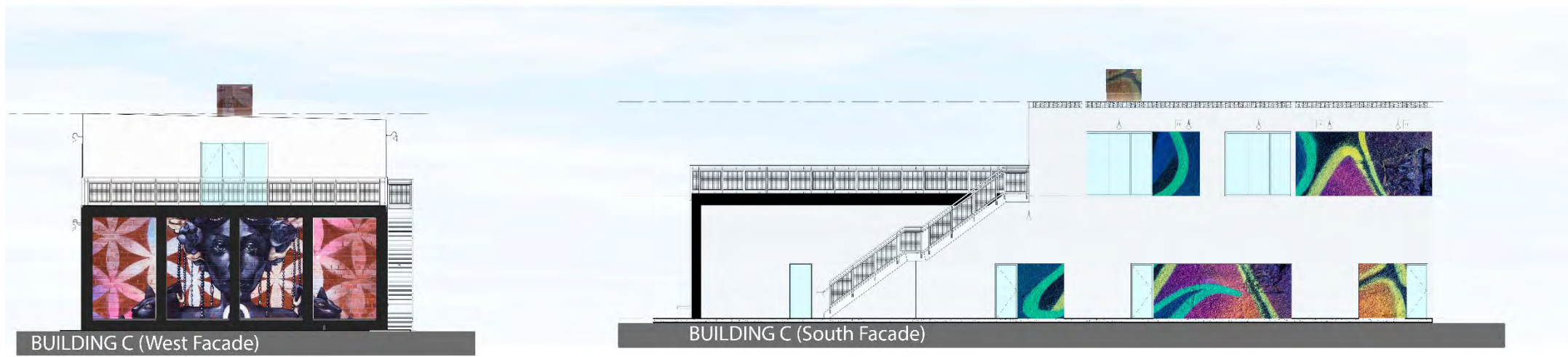
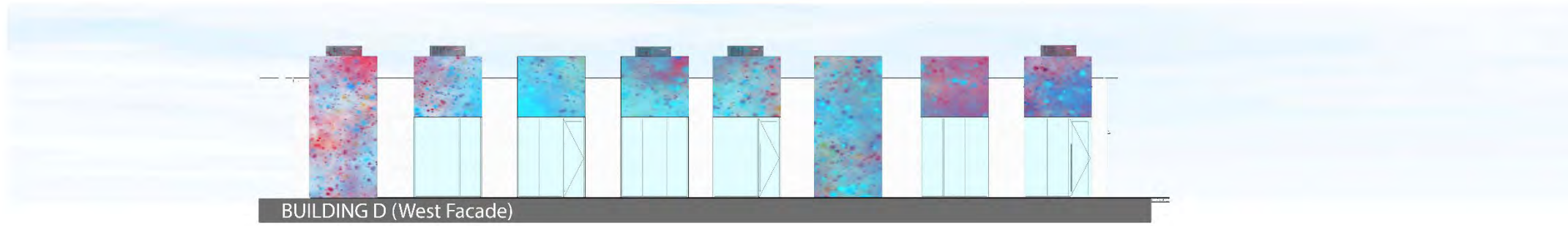



BUILDING A & B
EAST FACADE



BUILDING A & B
WEST FACADE



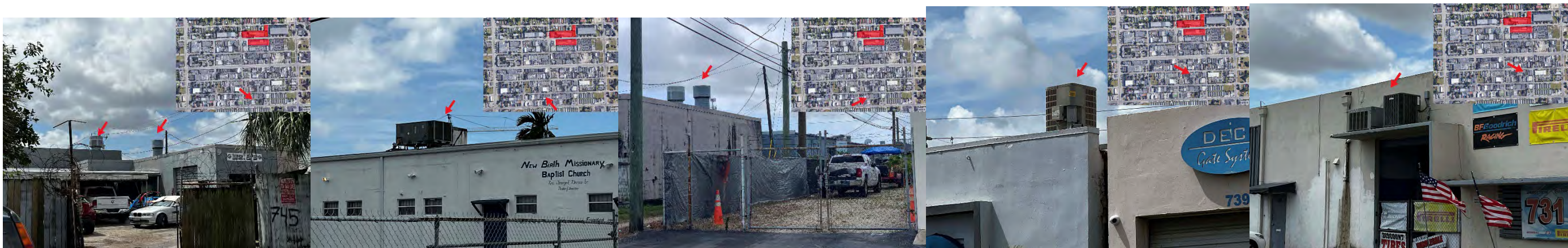













MARTY KIARD
BRWARD
 COUNTY
 PROPERTY APPRAISER

Site Address	710-726 NW 5 AVENUE, FORT LAUDERDALE FL 33311	ID #	4942 34 07 0100
Property Owner	THRIVE DEVELOPMENT GROUP LLC	Millage	0312
Mailing Address	9232 ABBOTT AVE MIAMI FL 33154	Use	48
Abbr Legal Description	PROGRESSO 2-18 D LOTS 21,28 THRU 37 AND E1/2 OF LOTS 38 THRU 42 BLK 282		

The just values displayed below were set in compliance with [Sec. 193.011, Fla. Stat.](#), and include a reduction for costs of sale and other adjustments required by [Sec. 193.011\(8\)](#).

* 2022 values are considered "working values" and are subject to change.

Property Assessment Values					
Year	Land	Building / Improvement	Just / Market Value	Assessed / SOH Value	Tax
2022*	\$820,130	\$360,290	\$1,180,420	\$1,180,420	
2021	\$455,630	\$1,441,070	\$1,896,700	\$1,756,830	\$37,123.65
2020	\$455,630	\$1,195,240	\$1,650,870	\$1,597,120	\$33,450.84

2022* Exemptions and Taxable Values by Taxing Authority				
	County	School Board	Municipal	Independent
Just Value	\$1,180,420	\$1,180,420	\$1,180,420	\$1,180,420
Portability	0	0	0	0
Assessed/SOH	\$1,180,420	\$1,180,420	\$1,180,420	\$1,180,420
Homestead	0	0	0	0
Add. Homestead	0	0	0	0
Wid/Vet/Dis	0	0	0	0
Senior	0	0	0	0
Exempt Type	0	0	0	0
Taxable	\$1,180,420	\$1,180,420	\$1,180,420	\$1,180,420

Sales History			
Date	Type	Price	Book/Page or CIN
5/25/2017	WD-Q	\$1,300,000	114424160
10/17/2003	WD	\$825,000	36877 / 304
8/20/2002	WD	\$665,000	33744 / 942
10/22/1998	QCD	\$100	29140 / 1490
2/6/1996	QC*	\$100	24531 / 525

Land Calculations		
Price	Factor	Type
\$18.00	45,563	SF
Adj. Bldg. S.F. (Card, Sketch)		17277

* Denotes Multi-Parcel Sale (See Deed)

Eff./Act. Year Built: 1984/1983

Special Assessments								
Fire	Garb	Light	Drain	Impr	Safe	Storm	Clean	Misc
03						F2		
W								
17277						45563		



[Department of State](#) / [Division of Corporations](#) / [Search Records](#) / [Search by Entity Name](#) /

Detail by Entity Name

Florida Limited Liability Company
THRIVE DEVELOPMENT GROUP LLC

Filing Information

Document Number	L19000197129
FEI/EIN Number	84-3072111
Date Filed	08/06/2019
State	FL
Status	ACTIVE
Last Event	CORPORATE MERGER
Event Date Filed	09/11/2019
Event Effective Date	NONE

Principal Address

746 NW 5TH AVENUE
FT LAUDERDALE, FL 33311

Mailing Address

746 NW 5TH AVENUE
FT LAUDERDALE, FL 33311

Registered Agent Name & Address

THE TARICH LAW FIRM P.A.
1946 TYLER STREET
HOLLYWOOD, FL 33021

Authorized Person(s) Detail

Name & Address

Title MGR

FISH, JONATHAN
746 NW 5TH AVENUE
FT LAUDERDALE, FL 33311

Title MGR

FISH, ABRAHAM
746 NW 5TH AVENUE
FT LAUDERDALE, FL 33311

Annual Reports

Report Year	Filed Date
2020	03/18/2020
2021	03/31/2021
2022	01/31/2022

Document Images

01/31/2022 -- ANNUAL REPORT	View image in PDF format
03/31/2021 -- ANNUAL REPORT	View image in PDF format
03/18/2020 -- ANNUAL REPORT	View image in PDF format
09/11/2019 -- Merger	View image in PDF format
08/06/2019 -- Florida Limited Liability	View image in PDF format